

Understanding the Digital World



Evolution of GSM-R

ERA/2014/04/ERTMS/OP

Final Report

**For the attention of the European Railway Agency
ERTMS**

V3.5

The opinions expressed in this study are those of the authors and do not necessarily reflect the views of the European Railway Agency (ERA).

40037 – April 2015

Prime contractor: IDATE

Subcontractor: WIK

●●● IDATE Project Manager

Frédéric PUJOL

+33 (0)4 67 14 44 50 f.pujol@idate.org

●●● WIK Consult

J. Scott MARCUS

www.idate.org

wik 
CONSULT



DIGIWORLD
by IDATE

About IDATE and DigiWorld Institute



Founded in 1977, IDATE has gained a reputation as a leader in tracking telecom, Internet and media markets, thanks to the skills of its teams of specialized analysts. Now, with the support of more than 40 member companies – which include many of the digital economy’s most influential players – the newly rebranded DigiWorld Institute has entered into a new stage of its development, structured around three main areas of activity:

- › **IDATE Research**, an offer of market intelligence publications
 - › **IDATE Consulting**, time-tested analysis
 - › **DigiWorld Institute**, a think tank on the digital economy.
-

Contents

Executive Summary	7
The need for a successor to GSM-R	7
Impact assessment as a tool for assessing Options going forward	7
A multidimensional problem	8
A cross-sectoral European view	8
A Member State view	9
A view from the perspective of the European rail sector	9
Recommendations	10
1. Introduction	13
1.1. The need for a successor to GSM-R	13
1.2. Precursors to the current study	14
1.3. Goals of the current study	15
1.4. Goals of this Final Report	16
1.5. The way forward	16
1.6. Our methodology	17
1.7. Structure of this document	18
2. Multiple problems call for multiple solutions	19
2.1. The analysis done to date	19
2.2. A multi-layered decision process	20
2.3. Drivers for these decisions	21
2.3.1. Evolving PPDR and energy functional requirements	21
2.3.2. Evolving railway functional requirements	23
2.3.3. Evolving technology	23
2.4. Relationship to the structure of the remainder of this document	24
3. The European cross-sectoral level	25
3.1. The Problem at the European cross-sectoral level	26
3.2. The Objectives	26
3.3. Options	26
3.3.1. Key dimensions along which Options and Sub-Options differ from one another ..	26
3.3.2. Options for European overall cross-sectoral policy	27
3.4. Assessment of impacts	32
3.4.1. Definition of criteria	32
Effectiveness	32
Efficiency	33

3.4.2.	Qualitative assessment	33
4.	The Member State level.....	37
4.1.	Differences in the respective positions of the Member States	38
4.1.1.	Coverage requirements	38
4.1.2.	Cost implications	39
4.1.3.	Integration with PPDR capabilities.....	40
4.1.4.	Multi-technology networks	41
Satellite	41	
Wi-Fi.....	42	
4.2.	The Problem at the Member State (national) level	42
4.3.	Rail-specific Objectives at Member State level	43
4.4.	Network Options.....	43
4.4.1.	Rail-specific networks.....	45
GSM-R	45	
GSM-R successors	45	
4.4.2.	Unmodified commercial mobile networks	46
4.4.3.	Networks with rail (and PPDR) enhancements.....	46
Enhanced commercial mobile networks	47	
Mission-critical networks	47	
4.4.4.	Hybrid networks.....	47
4.5.	Assessment of impacts	47
4.5.1.	Definition of criteria.....	47
Effectiveness	47	
Efficiency	48	
Coherence.....	48	
4.5.2.	Qualitative assessment	49
ETCS data applications.....	49	
Voice applications	56	
5.	The European rail level	59
5.1.	The Problem at European rail level.....	59
5.2.	Rail-specific Objectives	60
5.3.	Control instruments available to European rail authorities.....	60
5.4.	Elements of the Preferred Option.....	61
5.4.1.	Bearer independent applications in support of a range of bearer technologies ...	61
5.4.2.	Cost, certification, and the number of supported configurations	63
5.4.3.	3GPP Release 12, Release 13, and subsequent releases	64
5.4.4.	Current mobile technology: EDGE, UMTS/3G, and LTE	66
5.4.5.	Evolution to 5G mobile services	66
5.4.6.	Satellite networks	67
5.4.7.	Wi-Fi networks.....	67
5.5.	Assessment of Impacts	68
5.5.1.	Definition of criteria.....	68
Effectiveness	68	
Efficiency	69	

5.5.2. Qualitative assessment	69
6. Findings and recommendations.....	71
6.1. Findings	71
6.2. Recommendations to the ERA and the European rail sector	72
7. Glossary.....	74

Tables

Table 1.	Proposed Options for European overall cross-sectoral policy.....	30
Table 2.	Apparent implications of Options and Sub-Options for the approach to spectrum, and integration with commercial MNO services, PPDR, and/or energy.	31
Table 3:	Assessment of impacts	33
Table 4.	Qualitative assessment of various approaches at Member State level – ETCS data	50
Table 5.	Qualitative assessment of various approaches at Member State level – Voice	57
Table 6.	Anticipated evolution and deployment of mobile standards in Europe.	65
Table 7:	Qualitative assessment of various approaches at European rail level	69

Figures

Figure 1.	The way forward: cab radio evolution.	17
Figure 2:	Study methodology	18
Figure 3	Interrelated decisions must be taken at different levels.	21
Figure 4.	Main Options available to the Member States.	44
Figure 5.	Functionality of a standard commercial mobile network versus that of a network enhanced to support rail and/or PPDR.	45

Executive Summary

This is the Executive Summary of the draft Final Report for the study “Evolution of GSM-R”, which was conducted by IDATE and WIK-Consult GmbH for the European Railway Agency (ERA).

Operational rail communications play a key role in ensuring continuous, safe and interoperable railway transportation. This study (and further ERA work based on it) is inspired by the need to ensure that this continues to be the case as technology evolves.

The need for a successor to GSM-R

Some studies have assessed the operational communication needs of the European rail sector in recent years. All have found that the current operational system, GSM-R, is a good fit for current needs, and that functional needs are evolving only gradually.¹ Bandwidth requirements for rail operations and signalling systems are growing only very slowly today.² GSM-R technology can evolve to accommodate mid-term needs.

A successor to GSM-R is required primarily due to the expected obsolescence of GSM-R. GSM-R builds on existing GSM mobile standards, using the frequency bands 876-880 MHz (uplink) and 921-925 MHz (downlink) that are harmonised within CEPT for the operational communication of railway companies (GSM-R) in accordance with current mobile technology. GSM is a second generation mobile technology, but the industry is already moving to LTE³ (arguably a fourth generation [4G] technology) and is expected to evolve to fifth generation (5G) technology after 2020. The ability of the rail industry to continue to support GSM-R beyond roughly 2030 is doubtful. Given the long procurement cycles in the rail sector, planning for a successor needs to begin now.

Stakeholders also seek cost reductions, especially in *operational expense (OPEX)*, which could be also a driver in some cases to look for other communication solutions.

Impact assessment as a tool for assessing Options going forward

Our approach throughout is inspired by European Impact Assessment methodology. Among the European institutions, Impact Assessment provides a useful means of analysing costs and benefits of prospective policy interventions. Impact Assessment, as defined by the European Commission,⁴ is conducted by (1) clearly identifying the Problem to be addressed; (2) identifying a series of General and Specific Objectives that should be achieved in doing so; (3) identifying several plausible Options constituting policy interventions that might

¹ Wouter Malfait (2014), “Ex-Post Evaluation: Operational Requirements of Railway Radio Communication Systems”, ERA. “[T]here is no major indication of functionalities not used of functionalities missing...”
<http://www.era.europa.eu/Document-Register/Pages/Ex-post-Evaluation-%E2%80%93-TSI-CCS-%E2%80%93-Operational-Requirements-of-Railway-Radio.aspx>

² This view is not universal. Some rail stakeholders argue that bandwidth limitations of GSM-R are a cause, not a result, of the lack of new applications. Others argue that the emerging developments will have greater impact than has been assumed. In this report, however, we have taken the slow evolution of functional requirements, as found in the previous studies, as a point of departure.

³ LTE corresponds to the radio access part (or eUTRAN) and EPC, Evolved Packet Core, the core network of the 3GPP mobile broadband standard.

⁴ European Commission (2009), “Impact Assessment Guidelines”, 15 January 2009, at http://ec.europa.eu/smart-regulation/impact/commission_guidelines/docs/iag_2009_en.pdf.

achieve the desired Objectives; and (4) assessing the likely Impacts, both positive and negative, of each of the Options (see section 3.3 for details on the options).

Properly applied, Impact Assessment serves not only to assess impacts of decisions already reached, but also to assist in the proper formulation of policies in the first place.

A multidimensional problem

Arriving at a solution is complex. In order to make progress, it is necessary to decompose the problem into multiple Problems and multiple decisions to be taken, each of which must reflect (1) evolving functional requirements on the part of the users of the relevant service; and (2) evolving technology:

- A set of European cross-sectoral decisions that must be taken as to (1) whether to handle PPDR, rail, intelligent highway transport, and energy together, (2) the degree to which a solution could be common among these sectors (and possibly common with commercial mobile networks), and (3) how such a cross-sectoral approach might work if it were desired;
- A set of European rail-specific decisions; and
- A set of Member State decisions.

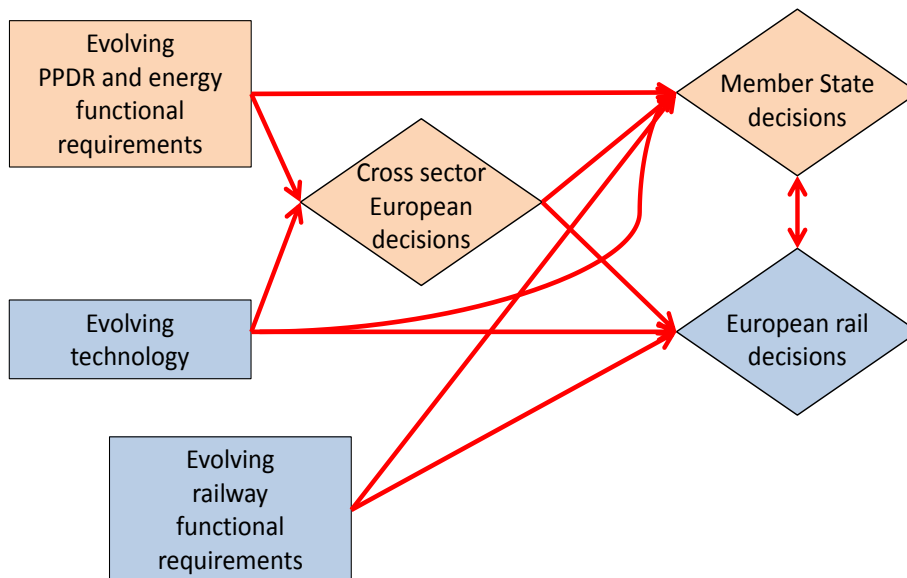

A cross-sectoral European view

The Problem for European policymakers (and not just for the rail sector) is to identify technical, spectrum management, and policy measures to be undertaken to enable continued provision of mission critical services, however defined, to the European public protection and disaster relief (PPDR), energy and transport sectors (including rail) as technology and markets evolve going forward.

The decision-makers at this level are the European institutions. The decision-makers span multiple sectors – these are not just rail decisions.

A recent study on behalf of the European Commission⁵ claimed that the cost of a cross-sectoral network based on commercial mobile services for *Public Protection and Disaster Relief (PPDR)* and rail might well be somewhat less than that of the private networks used

⁵ Simon Forge, Robert Horvitz and Colin Blackman (2014), "Is Commercial Cellular Suitable for Mission Critical Broadband? Study on use of commercial mobile networks and equipment for 'mission-critical' high-speed broadband communications in specific sectors".

today, even after allowing for the costs of hardening the network to provide reliability and expanding its coverage. There is, however, considerable uncertainty about this claim. Their analysis was primarily relative to existing PPDR networks, and only tangentially relevant to operational rail network requirements; moreover, their analysis rests on the assumption that a various reliability, coverage, management and practical requirements can be met that, in practice, quite possibly cannot be met.

A Member State view

Many decisions will ultimately be taken at different times in different Member States (bearing in mind that a number of European countries that are not Member States of the EU or EEA apply the CCS TSI).

The decision-makers at this level are Member State governments. The decision-makers span multiple sectors – these are not necessarily just rail decisions. The ministry of transport, however defined, will typically play a role, as will the rail Infrastructure Manager (IM). The Member State spectrum management authority (SMA) will also play a decisive role. These are complex decisions involving many stakeholders.

Coverage requirements can differ greatly among different wireless applications. For rail operational networks, they differ as well as a function of speed and traffic of the lines.

There could be enormous value in re-use of the existing trackside GSM-R locations by a future replacement system. This does not necessarily imply that the same ownership and control model be carried forward. As long as future successors to GSM-R were to operate in frequency bands similar to or slightly lower than the frequency band of GSM-R, the same route kilometres could be covered using the same sites.

Multi-technology support has potential value. Current geosynchronous satellites are subject to substantial latency, but could nonetheless be better than lack of coverage in remote areas. In the future (post 2030), use of MEO satellites to cover remote areas might bring considerable benefits.

A view from the perspective of the European rail sector

Decisions at this level are core to the current study. The decision-makers are European rail authorities: the European Commission (DG MOVE), with support from the European Rail Agency (ERA), and the national authorities at each Member State. Many contributors from the sector influence these decisions with their expertise, including, the Union Internationale des Chemins de Fer (UIC), a worldwide organisation, and other representative groups, such as CER, EIM, ERFA, and EPTTOLA.

Under the Option that we deem to be preferred, European specifications (in the CCS TSI,) would be revised to permit or require, in suitable configurations bearer independent applications in support of a small, well-chosen range of technologies, potentially including current and future LTE; possibly Wi-Fi or successor technologies; and possibly satellite networks (for lines where conditions are suitable). When specifications are sufficiently mature, 5G will be a strong candidate for inclusion.

We assume that it is mandatory to solve this transition issue for mission critical train functionality, primarily for train operation. The possible ability however of the same solution to meet additional rail business requirements, or perhaps even passenger entertainment needs, is not a mandatory requirement; however, meeting these additional needs could be factored in as a possible price/performance optimisation.

The detailed impacts will depend on myriad decisions; however, it is fairly clear that a failure on the part of European rail authorities to expand specifications so as to accommodate a practical evolution of the GSM-R system would result in a proliferation of inconsistent and possibly non-interoperable solutions at Member State level, thus reducing interoperability, ability to roam, and economies of scale at European level.

Conversely, even if Member State decisions are far in the future, a coordinated standards-based approach at European level can generate substantial benefits.

Recommendations

Based on our analysis, our recommendations to the ERA and to the European rail sector are as follows.

- Recommendation 1. The relevant specifications need a serious overhaul in order to ensure that the rail operational functionality that operates above GSM-R is properly de-coupled from its underlying transport and is future proof. 62
- Recommendation 2. ERA and the European rail sector should study the degree to which necessary rail voice communications functionality could be provided by a “lowest common denominator” network (such as a purely IP-based radio network) that contains no special support at all for rail-specific voice communications functionality such as Rail Emergency Call and Group Call. (Application and end-to-end performance and reliability requirements might still be relevant.) 63
- Recommendation 3. A successor to GSM-R could support more permissible configurations than are possible today, but care must be taken to ensure that the number of supported configurations is no greater than is truly necessary, sustainable, and regularly reviewed.64
- Recommendation 4. As new bearers are introduced, continued interoperability with GSM-R as deployed must be maintained. 64
- Recommendation 5. ERA and the European rail sector should consider carefully European certification requirements for operational rail communications. A more granular and flexible certification of operational rail communications equipment would appear to be in order. There should be as few national specificities in the systems as possible (ideally none at all) with the goals of achieving a single certificate in Europe and thereby optimising costs. 64
- Recommendation 6. The rail sector would be well advised to ensure that rail communications experts participate in 3GPP SA6 standards activities in order to ensure that these potentially crucial standards fully and appropriately address rail communications needs. 65
- Recommendation 7. Planning should begin incorporating 3GPP LTE-based standardised solutions into a successor to GSM-R. This should be done, as much as possible, in a manner that is independent of specific LTE releases. 66
- Recommendation 8. ERA should consider initiating a study on the use of 3GPP LTE in the existing 4 MHz GSM-R uplink and downlink bands, and possible coexistence with GSM-R in the band. The possible role and relevance (if any) of the E-GSM-R extension bands (873-876 MHz (Uplink) and 918-921 MHz (Downlink)) should also be reviewed at that time.. 66
- Recommendation 9. ERA and the European rail sector should monitor the evolution of radio technologies, such as 5G mobile services, and should consider incorporating support into a successor to GSM-R once the standards are sufficiently mature. 67
- Recommendation 10. The ERA, the European Space Agency (ESA), and the European rail sector should continue to study the degree to which the use of satellite is feasible and practical for operational rail communications. Current GEO (and possibly LEO) satellites might possibly be acceptable for lines in remote areas with suitable traffic characteristics. Future MEO satellites are likely to have still greater applicability. 67
- Recommendation 11. ERA and the European rail sector should consider whether the inclusion of Wi-Fi (and/or some other low bandwidth optimised radio bearer) into standards for a successor to GSM-R is warranted. The prime motivations to do so would be to increase capacity in train stations and shunting yards, and also to reduce the cost of communication infrastructures. Coexistence with consumer Wi-Fi would need to be assessed, as well as the planned migration schedule to successors to today's GSM-R. 68

Findings

- Finding 1. The need for a successor to GSM-R is motivated by anticipated eventual obsolescence of GSM, capacity limitations in GSM-R, and a desire to reduce costs. Previous studies have found that functional requirements and bandwidth demand are evolving only slowly; however, not all stakeholders agree. 14
- Finding 2. Multiple studies have assessed possible ways forward for operational rail communications (and for other mission critical networks)..... 15
- Finding 3. It is exceedingly difficult to express clear, non-overlapping Options with which to address this Problem. 20
- Finding 4. We find it useful to distinguish among three interrelated sets of decisions: (1) A cross-sectoral decision at European level as to how to handle PPDR, energy, intelligent highway transport, and rail communications overall; (2) a rail-specific decision; and (3) Member State (national) decisions. 21
- Finding 5. Public Protection and Disaster Relief (PPDR) forces hope to upgrade their communications capabilities using broadband technology. 22
- Finding 6. Needs for the energy sector are driven primarily by smart metering and smart grid applications; these have, however, different network implications. 22
- Finding 7. Railway functional requirements for train operational communications have been found in previous studies to be evolving only slowly; however, needs may increase in the medium-far future. 23
- Finding 8. There are commonalities between rail and other mission-critical applications for voice and data radio services, but also important differences such as speed. 23
- Finding 9. Technology is evolving in ways that provide many new opportunities going forward. 24
- Finding 10. We are analysing European cross-sectoral Options and Sub-Options from least active intervention to most active intervention. A range of solutions are possible, with different implications in terms of cost and ease of implementation. 28
- Finding 11. For reasons outlined in SCF (2014), the cost of a cross-sectoral network based on MNO services for PPDR and rail might well be somewhat less than that of the private networks used today, even after allowing for the costs of hardening the network to provide reliability and expanding its coverage. At the same time, it is necessary to bear in mind that their analysis was primarily relative to existing PPDR networks, and only tangentially relevant to operational rail network requirements; moreover, their analysis rests on the assumption that a various reliability, coverage, management and practical requirements can be met that, in practice, quite possibly cannot be met. Further study is needed. 35
- Finding 12. Taking migration costs into account (which is not fully possible until far more is known about the migration) an Enhanced Business as Usual approach (with private rail networks using modernised technology) might well be comparable in efficiency to the various network sharing sub-Options that we have considered. 35
- Finding 13. If the GSM-R bands can eventually be released, the opportunity cost for the European Union as a whole of up to roughly €2.5 billion could be freed. This number rests however on many assumptions, and must be interpreted with caution. 36
- Finding 14. Coverage requirements can differ greatly among different wireless applications. For rail operational networks, they differ as well as a function of speed and traffic of the lines. Stations, depots and shunting yards tend to require coverage at greater bandwidth than is needed elsewhere. 39
- Finding 15. There could be enormous value in re-use of the existing trackside GSM-R locations by a future replacement system. This does not necessarily imply that the same ownership and control model be carried forward. As long as a future successor to GSM-R were to operate in frequency bands similar to or slightly lower than the frequency band of GSM-R, and assuming no radical growth in bandwidth demands, the same route kilometres could be covered using the same sites. 40
- Finding 16. Multi-technology support has potential value. Current geosynchronous satellites are subject to substantial latency, but could nonetheless be better than lack of coverage in remote areas, and are in use for operational rail communications in other parts of the world. In the future (post 2030), use of MEO satellites to cover remote areas might bring considerable additional benefits. 42
- Finding 17. At Member State level, Options differ largely on the degree to which private networks, unmodified commercial networks, or commercial networks with modifications for mission critical services are use. Many hybrids are possible. 45

Finding 18. At this level of analysis, it is necessary to distinguish between voice requirements and (ETCS) data requirements. 58

Finding 19. Key elements of the Preferred Option for European rail authorities would appear to be to add specific capabilities to the relevant specifications to enable bearer independent applications in support of a small, carefully chosen range of bearer technologies, potentially including current and future LTE; possibly Wi-Fi or successor technologies; and possibly satellite networks (for lines where conditions are suitable). When specifications are sufficiently mature, 5G will be a strong candidate for inclusion. 61

Finding 20. The use of GPRS or EDGE to carry ETCS traffic is a positive development that is already ongoing. 66

Finding 21. Even if Member State decisions are far in the future, a coordinated standards-based approach at European level can generate substantial benefits. 70

1. Introduction

This is the draft Final Report for the study “Evolution of GSM-R”, study ERA/2014/04/ERTMS/OP⁶, which is being conducted by IDATE and WIK-Consult GmbH for the *European Railway Agency (ERA)*.

The document is published in the interest of soliciting feedback from interested parties, and to support future planning on the part of the ERA in particular and the European rail sector in general.

Operational rail communications play a key role in ensuring continuous, safe and interoperable railway transportation. This study (and further ERA work based on it) is inspired by the need to ensure that this continues to be the case as technology evolves.

1.1. The need for a successor to GSM-R

The need for a successor to GSM-R is driven primarily by the eventual obsolescence of the underlying GSM technology on which GSM-R is based.

GSM-R can be viewed as being in the middle of its life-cycle, with a remaining lifetime of at least 15 years from now. Since its introduction, GSM-R technology has been continuously evolving. There are various opportunities to Railway Undertakings (RUs) and Infrastructure Managers (IMs) to cope with their mid-term needs. Increase of capacity for voice and for data applications, packet switching, support of IP data communication, increased protection against interference, and increased availability by means of geo-redundant network core solutions could potentially address current and near-future requirements. Further enhancements to provide additional functionality and improved quality of service are under investigation.

The operational communication needs of the European rail sector have been assessed multiple times in recent years (see Section 1.2). These studies found that the current operational system, GSM-R, is a good fit for current needs, and that functional needs are evolving only gradually. Bandwidth requirements for rail operations are growing only very slowly today.⁷

In the course of this study, a number of stakeholders challenged these previous findings. Some argued that bandwidth limitations of GSM-R are a cause, not a result, of the lack of new applications. One *Infrastructure Manager (IM)* argued that lack of bandwidth in GSM-R is a serious and immediate problem.⁸ Some argue that ongoing work conducted in the UIC project on *Future Railway Mobile Communication Systems (FRMCS)*⁹ is likely to result in new functional requirements. *Automated Train Operation (ATO)* was mentioned,¹⁰ as well as video for maintenance¹¹ and for level crossing supervision.

⁶ The terms of reference can be found at <http://www.era.europa.eu/The-Agency/Procurement/Documents/TOR%20ERA%202014%2004%20ERTMS%20OP.pdf>

⁷ Wouter Malfait (2014), “Ex-Post Evaluation: Operational Requirements of Railway Radio Communication Systems”, ERA. “[T]here is no major indication of functionalities not used of functionalities missing...”

⁸ There are huge differences among the different countries as to the volume of voice and data applications. In some cases, the capacity limits of GSM-R are apparently being reached.

⁹ See for instance Chiel Spaans (2013), “Future Railway Mobile Communication Solutions: Summary of the UIC GSM-R Conference, Sept 2013”, at <http://www.era.europa.eu/conferences/CCRCC%202013/Documents/ERA%20CCRCC%20Conference%202013%20FRMCS%201.0.pdf>

¹⁰ *Driver Advisory Systems (DAS)* and other applications as indicated in Shift2rail were also mentioned.

¹¹ For instance, video from stationary locations or drones could be used to monitor level crossing, to observe bridges and viaducts for cracks and structural problems, and to protect against theft.

Consistent with the Terms of Reference specified by ERA, we have taken the slow evolution of functional requirements, as found in the previous studies, as a point of departure. Under this assumption, a successor to GSM-R is required primarily due to the expected obsolescence of GSM-R. GSM-R builds on existing GSM mobile standards, using the frequency bands 876-880 MHz (uplink) and 921-925 MHz (downlink) that are harmonised within CEPT for the operational communication of railway companies (GSM-R) in accordance with current mobile technology, together with the possibility to use the 873-876 / 918-921 MHz band (if available, when needed). GSM is a second generation mobile technology, but the telecommunication industry is already moving to LTE (arguably a fourth generation [4G] technology) and is expected to evolve to fifth generation (5G) technology after 2020. The ability of the rail industry to continue to support GSM-R beyond roughly 2030 is doubtful. Given the long procurement cycles in the rail sector, planning for a successor needs to begin now.

Stakeholders also seek cost reductions, especially in *operational expense (OPEX)*. Some expressed interest in capital expense (CAPEX) reduction through convergence with other networks (such as TETRA, commercial mobile networks, and/or Wi-Fi networks).

Stakeholder input and previous studies have also identified a strong desire to cleanly separate rail operational communication applications from the underlying radio bearer in order to facilitate smooth transition as the radio system continues to evolve.

Finding 1. The need for a successor to GSM-R is motivated by anticipated eventual obsolescence of GSM, capacity limitations in GSM-R, and a desire to reduce costs. Previous studies have found that functional requirements and bandwidth demand are evolving only slowly; however, not all stakeholders agree.

1.2. Precursors to the current study

This study needs to be understood as part of a line of inquiries that have been launched by the ERA and the European Commission (see also Section 2.1, and the Annex to this report).

In 2013, the ERA launched a project to analyse the current situation with respect to the communication system used for voice and data for rail traffic management. The possible evolution of the communication needs and different network ownership models were described. The resultant study (Analysys Mason (2014)), based on extensive interviews and including a SWOT analysis of strengths and weaknesses of various approaches, was published in February 2014.¹² The study evaluated six Options: (1) retain GSM-R; (2) new technology – same band; (3) new technology – new band; (4) new technology – with third party; (5) multiple prescribed technologies; and (6) multiple technologies – no prescription.

Meanwhile, the ERA itself conducted an extensive Ex-Post Evaluation of GSM-R as part of their programme. The results, again based on extensive stakeholder interaction, provide a valuable source of guidance as to perceived needs for railway operational radio communications.¹³

In addition, the European Commission launched a study to consider alternative ways of implementing “mission critical” communications in Europe, including not only rail but also energy and *public protection and disaster relief (PPDR)*. The resultant study (SCF (2014)), which in the end dealt primarily with PPDR and only tangentially with rail communications, identified significant opportunities for commercial Mobile Network Operators (MNOs) to meet mission critical communication needs, provided however that several rigorous requirements

¹² David Taylor, Nils Lofmark, Maria McKavanagh (2014), “Survey on operational communications (study for the evolution of the railway communications system)”. 25 February 2014, Ref: 37760-496v04.

¹³ Malfait et al. (2014), “Ex-Post Evaluation”, op. cit.

were fully met (which in the view of many experts are not at all likely to be met).¹⁴ Moreover, it is far from clear that this list of requirements is either correct or exhaustive:

- First the behaviour of commercial MNOs must be constrained to provide the services needed by mission critical users while preventing the use of “lock in” techniques to take unfair advantage of this expansion of the MNOs’ market power and social responsibility. Such changes include not just stronger commitments to network resilience, but the acceptance of limits on price increases and contract condition revisions, ownership continuity assurances, and a focus on quality of service for priority mission critical traffic. ...
- Commercial networks have to be “hardened” from RAN to core and modified to provide over 99% availability – with a target of “five nines”. Geographic coverage must also be extended as needed for mission critical purposes and indoor signal penetration improved at agreed locations.
- All this network hardening and extended coverage, along with the addition of essential mission critical functions and resilience, must be accomplished at reasonable cost. ...
- Hardened LTE networks must be able provide the different types of service required by each of the three sectors. Each sector uses broadband in quite different ways. ...
- However, there is a further high barrier: will commercial mobile networks be able to overcome ingrained Member State preferences for state controlled networks for applications that implicate public safety? This is not simply a legal, regulatory or economic question. ...¹⁵

This study identified the following policy Options, which do not precisely align with those of the Analysys Mason study: (1) dedicated networks and dedicated specialised equipment; (2) commercial MNO networks and commercial equipment; (3) dedicated networks with commercial networking equipment; (4) hybrid networks; and (5) a common multi-purpose network, perhaps regional in scale.

Finding 2. Multiple studies have assessed possible ways forward for operational rail communications (and for other mission critical networks).

1.3. Goals of the current study

The European Railway Agency (ERA) is in charge of the maintenance of the TSI Control Command and Signalling (CCS TSI), and is the system authority for ERTMS (that includes both the ETCS and the GSM-R parts).¹⁶ The agency is to ensure that the TSI is adapted to technical progress, market trends, and social requirements, and is responsible for proposing any amendments to the TSIs which it considers necessary to the European Commission.

The ERA established this study in order to evaluate the Options to address the evolution of operational rail communications, in light of the challenges identified in Section 1.1, in terms of:

- methodology for their assessment;
- feasibility of the options presented;
- selection of the most suitable options;
- possible operator concepts for railways according to the options selected;
- frequency availability for railways; analysis for the different applications and possible use of a common bandwidth for different services, as presented in the different options;
- possible evolution of the terminals and network infrastructures according to the options selected; and
- highlights for the economic assessment of the options studied.

¹⁴ Simon Forge, Robert Horvitz and Colin Blackman (2014), “Is Commercial Cellular Suitable for Mission Critical Broadband? Study on use of commercial mobile networks and equipment for ‘mission-critical’ high-speed broadband communications in specific sectors”.

¹⁵ Ibid.

¹⁶ See Article 12 of Regulation (881/2004), which provides the basis for the ERA.

The study was specifically not intended:

- to identify a single, preferred Option;
- to develop a transition plan to a preferred Option; or
- to reassess future functional needs for a successor to GSM-R, which were already evaluated in the Ex-Post Evaluation (2014) and in the Analysys Mason (2014) study.¹⁷

The ERA anticipates that the results of the study will be used as appropriate to prepare the evolution to the future concept. A number of future studies are planned to deal with aspects not addressed in this study.

1.4. Goals of this Final Report

This Final Report seeks to provide stakeholders with the study team's assessment of the problem, to provide stakeholders with an opportunity to review our thinking and respond to it, and to provide a basis for further planning and actions on the part of the ERA (see Section 1.5).

1.5. The way forward

This study is neither the beginning of the process (see Section 1.2) nor the end; rather, it is a significant milestone along a fairly long road.

The ERA presented its vision of the way forward during the final public workshop for this project, which took place in Lille on 11 February 2015. The ERA distinguishes between functionality, technology, spectrum management, and migration aspects of the broader problem. They seek to integrate specifications of next generation communication system(s) integrated into a CCS TSI revision in 2018. Specific elements would include:

- Technology dimension (chapter 4 of CCS TSI);
- Migration dimension (chapter 7 of CCS TSI); and
- An Impact Assessment in support.

A number of past, current and future activities support this vision.

- **Functionality dimension**
 - The ex-post analysis of operational radio requirements (2014)
 - UIC FRMCS
- **Network/Technology dimension**
 - The Analysys Mason study (2014)
 - This study (2014)
 - Further studies focusing on remaining points in defining the appropriate network and technology suitable options
- **Migration dimension**
 - A transition study to start in H2 2015

These activities need to be viewed as part of a longer planning and specification cycle. Consider, for instance, the anticipated sequence of cab radio evolution depicted in Figure 1.

¹⁷ Malfait et al. (2014), "Ex-Post Evaluation", op. cit.; and David Taylor et al. (2014), "Survey on operational communications (study for the evolution of the railway communications system)", <http://www.era.europa.eu/Core-Activities/Economic-Evaluation/Pages/Ex-Post-Evaluations.aspx> .

Figure 1. The way forward: cab radio evolution.

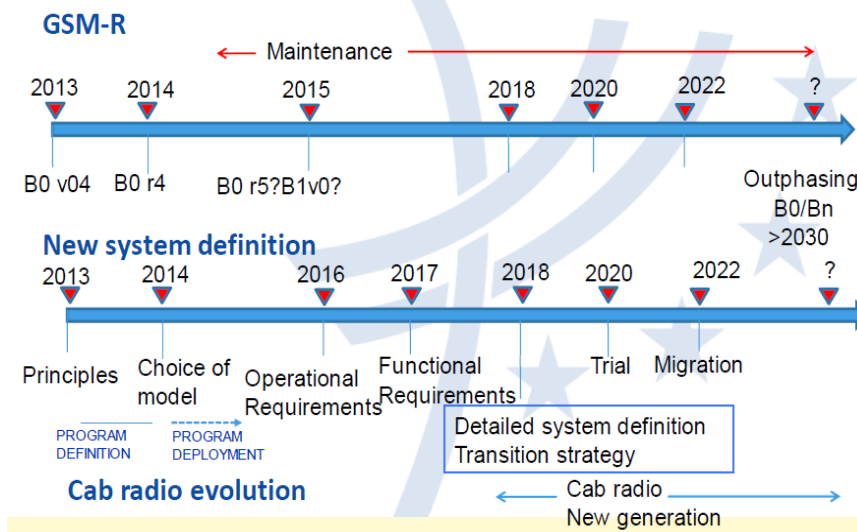

Source: ERA (public workshop, Lille, 11 February 2015)

1.6. Our methodology

Our approach throughout is inspired by European Impact Assessment methodology. Among the European institutions, Impact Assessment provides a useful means of analysing costs and benefits of prospective policy interventions. Impact Assessment, as defined by the European Commission,¹⁸ is conducted by (1) clearly identifying the Problem to be addressed; (2) identifying a series of General and Specific Objectives that should be achieved in doing so; (3) identifying several plausible Options constituting policy interventions that might achieve the desired Objectives; and (4) assessing the likely Impacts, both positive and negative, of each of the Options.

Properly applied, Impact Assessment serves not only to assess impacts of decisions already reached, but also to assist in the proper formulation of policies in the first place.

In this case, use of standardised Impact Methodology also assists ERA in communicating results to the European Commission, and assists the Commission (if necessary) in communicating results to the European Parliament and the Council.

¹⁸ European Commission (2009), "Impact Assessment Guidelines", 15 January 2009, at http://ec.europa.eu/smart-regulation/impact/commission_guidelines/docs/iag_2009_en.pdf.

Our overall approach is comprised of four steps:

- Step 1: Building an evidence base by means of desk research, extensive interviews, and three public workshops.
- Step 2: Framing the problem, using the vocabulary of European Impact Assessment.
- Step 3: Assessing the likely impact of each candidate Option for addressing the Problem.
- Step 4: Formulating recommendations.

Figure 2: Study methodology

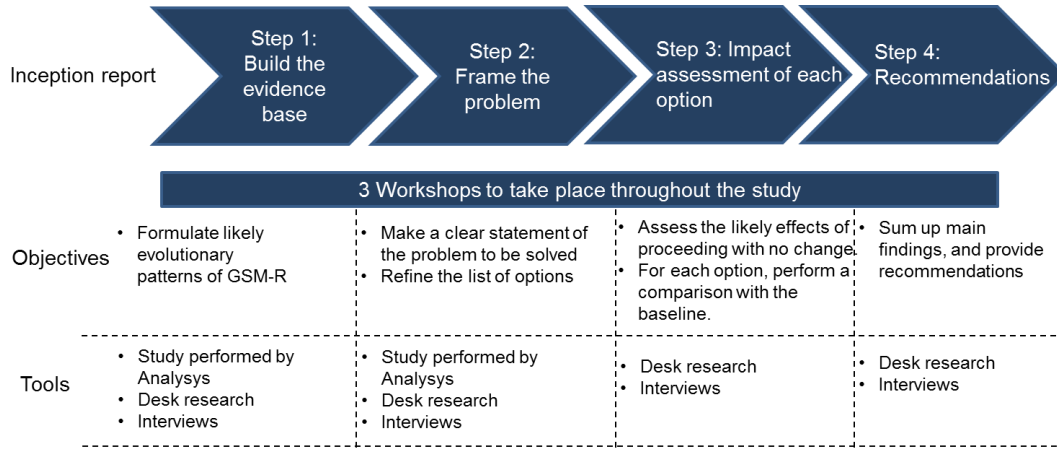

1.7. Structure of this document

Chapter 2 explains that the problem to be addressed is really comprised of multiple problems. On the one hand, there are European and Member State aspects; on the other, there are cross-sectoral aspects that relate not only to rail, but also to other mission-critical services such as public protection and disaster relief (PPDR) and energy.

Chapter 3 analyses possible cross-sectoral approaches that could be taken at European level, while Chapter 4 explores possible approaches at Member State level.

Finally, Chapter 4.5 explains the decisions that appear to be needed for the rail sector at European level, based on the analysis undertaken in Chapters 3 and 4.

2. Multiple problems call for multiple solutions

Key Findings

- It is exceedingly difficult to express clear, non-overlapping Options with which to address this Problem.
- We find it useful to distinguish among three interrelated sets of decisions: (1) A cross-sectoral decision at European level as to how to handle PPDR, energy, intelligent highway transport, and rail communications overall; (2) a rail-specific decision; and (3) Member State (national) decisions.
- Public Protection and Disaster Relief (PPDR) forces hope to upgrade their communications capabilities using broadband technology.
- Needs for the energy sector are driven primarily by smart metering and smart grid applications; these have, however, different network implications.
- Railway functional requirements for train operational communications have been found in previous studies to be evolving only slowly; however, needs may increase in the medium-far future.
- There are commonalities among these sectors, but there are also important differences.
- Technology is evolving in ways that provide many new opportunities going forward.

For purposes of our study, we are distinguishing between three interrelated sets of decisions: (1) A cross-sectoral decision at European level as to how to handle PPDR, energy, intelligent highway transport, and rail communications overall; (2) a rail-specific decision; and (3) Member State (national) decisions.

2.1. The analysis done to date

Both of the previous studies (Analysys Mason (2014) and SCF (2014)) used sets of Options that failed to convince rail stakeholders in the course of our Workshops to date, and that we also find insufficient for our purposes.

The Analysys Mason (2014)¹⁹ study used the following Options:

- retain GSM-R;
- new technology – same band;
- new technology – new band;
- new technology – with third party;
- multiple prescribed technologies; and
- multiple technologies – no prescription.

The SCF (2014)²⁰ used the following Options:

- dedicated networks and dedicated specialised equipment;

¹⁹ David Taylor, Nils Lofmark, Maria McKavanagh (2014), "Survey on operational communications (study for the evolution of the railway communications system)". 25 February 2014, Ref: 37760-496v04.

²⁰ Simon Forge, Robert Horvitz and Colin Blackman (2014), "Is Commercial Cellular Suitable for Mission Critical Broadband? Study on use of commercial mobile networks and equipment for 'mission-critical' high-speed broadband communications in specific sectors".

- commercial MNO networks and commercial equipment;
- dedicated networks with commercial networking equipment;
- hybrid networks; and
- a common multi-purpose network, perhaps regional in scale.

Comparing these Options, it is immediately clear that the Options are not aligned between the two studies.²¹

Second, it becomes clear that it is exceedingly difficult to express clear, non-overlapping Options. Options could potentially differ from one another according to:

- ownership and control model;
- technology;
- spectrum band(s);
- whether multiple ownership and control models are accommodated within or among the Member States;
- whether multiple technical and/or spectrum management models are accommodated within or among Member States.

The choices made interact with one another, but they do not uniquely determine one another. A dedicated rail operations network could, for example, be single technology or multi-technology.

For analogous reasons, great care must be taken in analysing “hybrid” solutions, because solutions could be hybrid across any of these dimensions, or indeed across more than one. In this study, we have attempted to more clearly delineate what we mean by “hybrid” in each specific instance where we use the term.

Finally, and most problematic from our perspective, the previous work (both Analysys Mason (2014) and SCF (2014)) has analysed Options as if there were a single decision to be made. There will in practice be multiple decisions. These decisions will in practice be made at quite different times, at different administrative levels (national versus European), and by different sets of decision-makers.

Finding 3. It is exceedingly difficult to express clear, non-overlapping Options with which to address this Problem.

2.2. A multi-layered decision process

We believe that it is necessary instead to decompose the problem into multiple Problems and multiple decisions to be taken,²² as shown in Figure 3:

- A set of European cross-sectoral decisions that must be taken as to (1) whether to handle PPDR, rail, intelligent highway transport, and energy together, (2) the degree to which a solution could be common among these sectors (and possibly common with commercial mobile networks), and (3) how such a cross-sectoral approach might work if it were desired;
- A set of European rail-specific decisions; and
- A set of Member State decisions.

Different aspects of the broader problem are addressed at different decision levels. Wherever new harmonised spectrum might be required, for instance, this would necessarily be addressed at European level, and generally with consideration of impacts on sectors other than rail. Decisions of what to deploy, and where, and how, tend by contrast to be dealt with at Member State level, albeit subject to rules and guidelines established at European level.

²¹ Indeed, the SCF study appears to make no reference whatsoever to the earlier Analysys Mason (2014) study.

²² For that matter, there is also an interaction with worldwide spectrum policy (consider the World Radiocommunication Conference 2015 (WRC-15)); however, the linkage is not crucial to the point where it needs to be explicitly modelled.

Each of these decisions must reflect (1) evolving functional requirements on the part of the users of the relevant service; and (2) evolving technology.

The EU level rail sector decision influences, but does not control, the cross-sectoral decision; conversely, the EU rail sector more or less controls the decision for its sector, but the cross-sectoral decision (together with Member State decisions) bounds the frontier of possibilities within which the rail sector decision can be taken.

Member States will make their own decisions, within a framework that is set at European level. The European framework should facilitate, or at least not hinder, sensible decisions at Member State level.

The complex interdependencies among these decisions cannot be ignored.

Figure 3 Interrelated decisions must be taken at different levels.

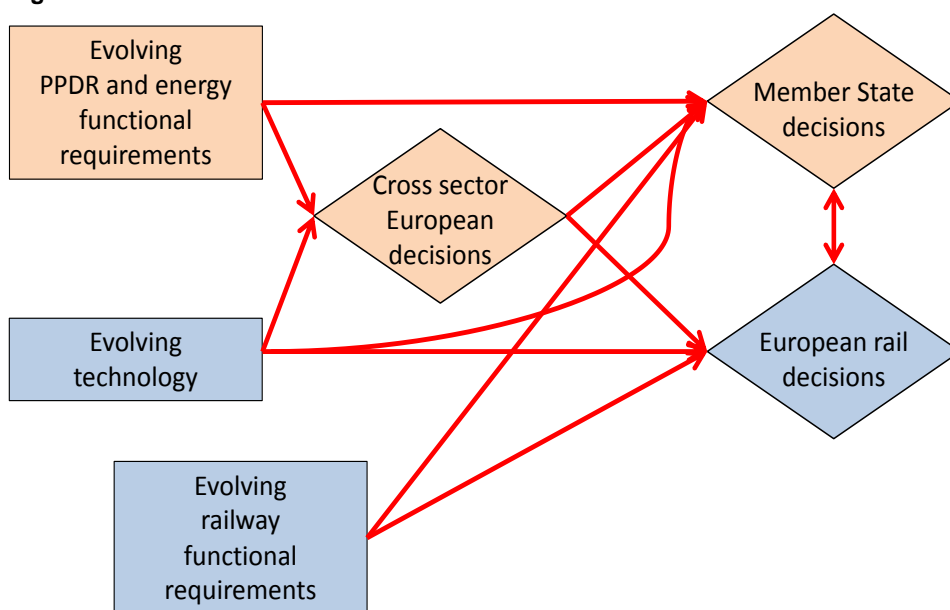

Finding 4. We find it useful to distinguish among three interrelated sets of decisions: (1) A cross-sectoral decision at European level as to how to handle PPDR, energy, intelligent highway transport, and rail communications overall; (2) a rail-specific decision; and (3) Member State (national) decisions.

2.3. Drivers for these decisions

The decisions to be taken are driven (as shown in Figure 3) in large measure by (1) evolving PPDR and energy functional requirements, (2) evolving railway functional requirements, and (3) evolving technology.

2.3.1. Evolving PPDR and energy functional requirements

Public Protection and Disaster Relief (PPDR) forces continue to rely on mission critical voice services, which are expected to continue to be carried by the existing dedicated voice and narrowband TETRA and TETRAPOL networks for some ten to fifteen years.²³ At the same time, PPDR users are increasingly looking to upgrade their communications capabilities

²³ CEPT ECC Report 199 (2013), “User requirements and spectrum needs for future European broadband PPDR systems (Wide Area Networks)”.

using mobile broadband technology. Video is of particular interest as a means of enabling commanders to see what is happening in the field (and it is for this reason that bandwidth requirements are great for upload than for download). Firefighters are interested in seeing building plans, and need indoor coverage.²⁴

It is fairly common for PPDR forces from one Member State to assist in the event of a disaster in another;²⁵ consequently, interoperability and roaming issues are becoming highly relevant to PPDR, just as they are in the rail sector.

The energy sector is seeing possible increasing demand for radio communications if smart metering increases. Smart meter communications use a wide range of bearers, including signalling over the power line (power-line communications (PLC), long range UHF radio, unlicensed mesh radio and GPRS. Smart metering is an application which is not critical; smart grid, on the other hand, is a critical application that requires a fine level of control with a fast response time. The proliferation of many power generation sources, such as solar generation on houses and wind farms, connected to an electricity grid which was designed to feed power from a few large power stations to many users, is giving rise to a situation where there has to be a fine level of control with a fast response time, otherwise there is a significant risk of instability, which in turn can lead to large power outages. Latency times of between 5 and 10 milliseconds are required.²⁶

Intelligent highway transport was not a specific target of our study, but stakeholders have rightly noted that highways and railways sometimes follow the same routes, and that potential synergies with communications for intelligent highway transport need to be considered.

Finding 5. Public Protection and Disaster Relief (PPDR) forces hope to upgrade their communications capabilities using broadband technology.

Finding 6. Needs for the energy sector are driven primarily by smart metering and smart grid applications; these have, however, different network implications.

²⁴ See SCF (2014): Simon Forge, Robert Horvitz and Colin Blackman (2014), "Is Commercial Cellular Suitable for Mission Critical Broadband? Study on use of commercial mobile networks and equipment for 'mission-critical' high-speed broadband communications in specific sectors"; and J Scott Marcus, Robert Burns et al. (2010): "PPDR Spectrum Harmonisation in Germany, Europe and Globally", December 2010, available at : http://www.cept.org/Documents/fm-49/1552/FM49_11_Info2_WIK_Report_PPDR_Spectrum_Harmonisation.

²⁵ See for instance Chapter 5 of J. Scott Marcus (2013), "The need for PPDR Broadband Spectrum in the bands below 1 GHz"; John Ure (2013), "Public Protection and Disaster Relief (PPDR) Services and Broadband in Asia and the Pacific: A Study of Value and Opportunity Cost in the Assignment of Radio Spectrum".

²⁶ David Taylor, Nils Lofmark, Maria McKavanagh "Survey on operational communications (study for the evolution of the railway communications system)" (Analysys Mason, 2014)

2.3.2. Evolving railway functional requirements

In terms of train operations, our working assumption based on previous studies is that railway functional requirements are evolving only slowly (see Section 1.1). We have assumed that functional requirements, even in 2030, are not radically different from functional requirements today.²⁷ Coverage requirements, however, change as new (high speed) lines are brought into service.

There are no final documents available today that indicate or justify new applications or additional needs. On the other hand, several activities in the railway sector are ongoing which may require robust wireless (data) communication.

Some examples are the inclusion of ATO (automatic train operation) in ETCS, studies on NGTC (next generation train control, with investigation of commonalities between “heavy rail” and “urban rail”), activities in the S2R (shift to rail) program and UIC activities on User requirement Specifications in the FRMCS project.

Finding 7. Railway functional requirements for train operational communications have been found in previous studies to be evolving only slowly; however, needs may increase in the medium-far future.

There are commonalities among these sectors, but there are also important differences. Economies of scale are important in all of these sectors. Interoperability and roaming are important in most of these sectors, but not in all, and moreover they do not have the same meaning in all sectors. The need to support movement at speeds in excess of 400 km/h is a rail-specific requirement.

Finding 8. There are commonalities between rail and other mission-critical applications for voice and data radio services, but also important differences such as speed.

2.3.3. Evolving technology

Technology is evolving in many different directions, some fairly predictable, others less so. This technological evolution provides many new opportunities going forward:

- **Internet Protocol (IP):** IP is being used as the foundation for nearly all data traffic, and increasingly for voice and video as well. This trend is unambiguous, and is unlikely to change by 2030.
- **Increasing transmission efficiency:** The migration from 3G mobile technologies to LTE is bringing an increase in spectral efficiency (e.g. bits/Hz), and the migration to LTE Advanced will take this evolution to the next step. The anticipated evolution to 5G in the coming years can be expected to lead to further improvements.²⁸
- **Increasing focus on spectrum sharing:** There is a gradual evolution away from purely exclusive spectrum assignments, and toward increasing use of various forms of shared or collective use. A particularly noteworthy trend is the potential use of *Licensed Shared Access (LSA)*, also known as *Authorised Shared Access (ASA)*, to enable more flexible sharing of spectrum than has been possible to date.²⁹
- **Increased focus on active network sharing:** Enhanced active network and equipment sharing as defined in 3GPP TS 23.251, 22.852 and 22.951 could enable

²⁷ Wouter Malfait (2014), “Ex-Post Evaluation: Operational Requirements of Railway Radio Communication Systems”, ERA. “[T]here is no major indication of functionalities not used or functionalities missing...”

²⁸ To the extent that these newer technologies lend themselves to larger contiguous spectrum bands, however, there may also be a tendency toward inefficiency for applications that do not require much bandwidth.

²⁹ The GSM Association (GSMA) defines LSA/ASA as complementary way of authorising and accessing spectrum, in addition to licensed (exclusive) and license-exempt (unlicensed), which enables the sharing of spectrum between a limited number of licensed users. Based on a commercial agreement and under an adequate regulatory framework, a non-mobile incumbent could allow part of their assigned spectrum to be used by a LSA/ASA user (such as a mobile operator).

several network operators to share hardware and control of a joint network.³⁰ This could be relevant to a number of the scenarios considered in this report.

- **Increasing flexibility in spectrum usage:** A number of technological trends, including the ability of LTE to aggregate multiple bands, together with the emergence of asymmetric downlink (ADL), are providing substantially greater flexibility in the use of spectrum. This can facilitate for instance the operation of LTE in licence-exempt bands.
- **Heterogeneous Networks (HetNets):** HetNets is part of the LTE-Advanced standard and enables smooth interworking between macro-cells and small-cells in a LTE network. It is increasingly common for “hot spots” to support both small cell mobile operations and Wi-Fi³¹. Many experts expect 5G technology to craft a seamless wireless network out of multiple, highly diverse forms of transmission, including for instance mobile and Wi-Fi networks.
- **Software Defined Radio (SDR):** It is increasingly feasible to reconfigure the operation of radio devices dynamically. Given the long procurement cycles for rail communications (and also for the PPDR and energy sectors), this could offer important operational flexibility.
- **5th generation wireless systems (5G):** A new generation of wireless services is expected to emerge by 2020 or soon thereafter. Many anticipate that it will offer substantial advantages beyond greater speed and spectral efficiency than current mobile technologies. Mesh networking, smooth integration with technologies such as Wi-Fi, and support for frequencies above 6 GHz are possible capabilities, but great uncertainty remains as to what will actually constitute 5G (see also Section 5.4.5).

Finding 9. Technology is evolving in ways that provide many new opportunities going forward.

2.4. Relationship to the structure of the remainder of this document

The remainder of this document discusses the three interrelated decisions in turn, starting with the European cross-sectoral level in Chapter 3), continuing with the Member State level in Chapter 4, and concluding in Chapter 4.5 with decisions to be taken at European level by the rail sector (since this is the issue that is of direct concern to this study).

³⁰ For an overview, see Alastair Brydon (2013), “3GPP Network Sharing Enhancements for LTE”, at <http://www.unwiredinsight.com/2013/3gpp-lte-ran-sharing-enhancements>.

³¹ J Scott Marcus and John Burns (2013), Impact of traffic off-loading and related technological trends on the demand for wireless broadband spectrum; a study for the European Commission, at <http://bookshop.europa.eu/en/study-on-impact-of-traffic-off-loading-and-related-technological-trends-on-the-demand-for-wireless-broadband-spectrum-pbKK0113239/>.

3. The European cross-sectoral level

Key Findings

- We are analysing European cross-sectoral Options and Sub-Options from least active intervention to most active intervention. A range of solutions are possible, with different implications in terms of cost and ease of implementation.
- For reasons outlined in SCF (2014), the cost of a cross-sectoral network based on MNO services for PPDR and rail might well be somewhat less than that of the private networks used today, even after allowing for the costs of hardening the network to provide reliability and expanding its coverage. There is, however, considerable uncertainty about this claim. Their analysis was primarily relative to existing PPDR networks, and only tangentially relevant to operational rail network requirements; moreover, their analysis rests on the assumption that a various reliability, coverage, management and practical requirements can be met that, in practice, quite possibly cannot be met. Further study is needed.
- Taking migration costs into account (which is not fully possible until far more is known about the migration) an Enhanced Business as Usual approach (with private rail networks using modernised technology) might well be comparable in efficiency to the various network sharing sub-Options that we have considered.
- If the GSM-R bands can eventually be released, the opportunity cost for the European Union as a whole of up to roughly €2.5 billion could be freed. This number rests however on many assumptions, and must be interpreted with caution.

This chapter deals with the European cross-sectoral level, as described previously in Chapter 2. First, we present the Problem at the European cross-sectoral level of analysis. We then explain how we distinguish the Options and Sub-Options from one another (Section 3.2), explain the Options and Sub-Options that we have derived (Section 3.3.2), and discuss how the various Options and Sub-Options differ from one another in terms of their expected respected impacts (Section 3.4). The Options describe different possibilities for providing radio network bearer services and the related technologies.

The Commission's release note to the SCF (2014) study notes that "... the Commission does not intend to adopt any legally binding measures related to the harmonisation of dedicated spectrum or obliging Member States to use commercial networks."³² Nonetheless, European policymakers will be obliged to take a number of relevant decisions or to choose not to take them (which is also a decision).

The decision-makers are the European institutions – the European Parliament, the Council, and especially the European Commission. The decision-makers span multiple sectors – these are not just rail decisions.

³² European Commission (2014), "Use of commercial mobile networks and equipment for mission-critical high-speed broadband communications in specific sectors (SMART 2013/0016)", 15 December 2014, at: <https://ec.europa.eu/digital-agenda/en/news/use-commercial-mobile-networks-and-equipment-mission-critical-high-speed-broadband>. This is consistent with the oral remarks of a senior Commission official, Andreas Geiss (DG CNECT, Head of Unit B4), who at the Final Presentation Workshop for the SCF (2014) study noted the Commission's interest in establishing "... EU guidelines ... for managing a commercially based mission critical network successfully. These EU guidelines would not be legally binding but should be based on subsidiarity principles, with the aim of offering guidance to MS and NRAs in drawing up both their regulatory framework for operating such networks with MNOs and their contract conditions." (as reported in Appendix E to SCF (2014)).

In this chapter, we progress as is customary in an Impact Assessment, from a definition of the Problem (Section 3.1), to a short list of Objectives (Section 3.2), to a list of Options (Section 3.3), and to an assessment of the Impacts of each of the Options (Section 3.4).

3.1. The Problem at the European cross-sectoral level

The cross-sectoral problem at European level is in principle the central theme of the SCF (2014) study, not of this study. That study defines their objectives, but does not appear to provide a statement of the cross-sectoral Problem that Europe needs to address.

We propose the following cross-sectoral Problem statement at European level:

- Identify technical, spectrum management, and policy measures to be undertaken to enable continued provision of mission critical services, however defined, to the European public protection and disaster relief (PPDR), energy and transport sectors (including rail) as technology and markets evolve going forward.

3.2. The Objectives

In an Impact Assessment, a clear view of the Objectives is essential in order to understand the Impacts of a proposed policy. In this report, we are decomposing the broader Problem into three distinct levels; consequently, it is necessary to distinguish Objectives for each of them. In practice, it is not altogether appropriate for this study (which deals specifically with the rail sector) to concern itself with non-rail objectives; nonetheless, in order to be able to proceed with meaningful analysis, we put forward the following General Objectives for the rail-specific Problem at Member State level:

- Support all current and anticipated future mandatory functionality for the “mission critical” sectors of rail, Public Protection and Disaster Relief (PPDR), and energy, at reasonable cost using modern, supportable technology.
- Enable continued operation without disruption during a transition period from existing modes of use to new modes of use. (In the case of the rail sector, this means that interoperability and roaming continue to be crucial during an extended transition period where GSM-R coexists with whatever succeeds it.)

3.3. Options

3.3.1. Key dimensions along which Options and Sub-Options differ from one another

Each of the Options and Sub-Options, both for the cross-sectoral problem and for the rail-specific problem, is distinguished from the others along multiple axes of choices, including:

- The **policy instruments** by means of which the European Union both supports and enforces the approach taken, and promotes harmonised approaches where they are warranted.
- The **ownership and control** models that are permitted within the scope of the policy framework.
- The **technologies** that are permissible.
- The **spectrum management** decisions that should or must be taken in support of the approach.

These relationships are not any-to-any. Only certain constellations of choices appear, at this point, to be sensible and internally consistent. Some choices of policy instrument, and of the ownership and control model, for instance, seem to imply the need for a dedicated spectrum band, while others do not.

3.3.2. Options for European overall cross-sectoral policy

We are analysing European cross-sectoral Options and Sub-Options from least active intervention to most active intervention.

The options at the top and bottom of the list seem less likely than those in the middle; nonetheless, it is useful to analyse them:

- For methodological completeness; and
- To enable comparisons to the Options and Sub-Options that seem more promising.

The choice of Option and Sub-Options influences the choice of technology and spectrum bands, but does not necessarily uniquely determine them.

With that established, we have defined the following initial set of Options and Sub-Options in terms of the first decision, i.e. the European cross-sectoral policy decision:

1. Business as usual
2. Member State actions subject to European support and coordination
 - a. Require network operators to deploy and operate (akin to universal service)
 - b. Impose spectrum licence obligations on network operators
 - c. Use of State Aid mechanisms to promote private networks, or enhancement of commercial networks
3. Direct European sponsorship
 - a. Strong coordination
 - b. European implementation (“We do it all”)

The creation and/or continuation of private networks are very much on the table, and they appear explicitly as an Option at Member State level in Chapter 3. In fact, they are possible here under both sub-Options of the Business as Usual Option, and would likely continue to be supported under all of the other Options as well.

Table 1 lists and summarises the Options and Sub-options, and describes the policy approach and technical approach implicit in each. Table 2 shows how the Options and Sub-options might possibly interact with or drive spectrum management decisions, and with decisions to integrate rail communications with commercial mobile networks (MNOs), with PPDR, or with energy networks.

These options also interact with the likely migration and time scale. Under Options 2 and 3, deployment of a network capable of supporting operational rail communications would be likely to begin circa 2020 driven by PPDR needs for broadband video services (which appear to be emerging more rapidly than new operational rail requirements).

It may be helpful at the outset to consider each of the Options and Sub-Options in turn.

- **Business as usual:** This Option assumes a continuation of present trends, with rail operations over private networks that are distinct from commercial mobile networks, and also distinct from other mission critical networks. Two sub-Options can be distinguished.
 - **Business fully as usual:** This Option/sub-Option is effectively required in any Impact Assessment. It reflects the most likely trajectory if no additional actions were undertaken to deal with the Problem beyond those already in motion or foreseeable today. It thus provides a baseline against which any other policy interventions can be judged. This Option assumes no greater activity at European level³³ than exists today (or will predictably exist based on initiatives already in progress) in order to prepare for future needs of PPDR, energy, and/or rail networks; however, Member States may undertake as much (or as little) as they may choose to foster the further evolution of train operational communications (and the other mission critical sectors). Member States would have the right to deploy private networks

³³ In case of continuation of private network, a European cross-sectoral action for spectrum allocation should be required

- under this Option (and the others), as they do today; no new European policy measures are needed to enable them to do so.
- **Enhanced business as usual:** In this sub-Option, rail continues to operate over private networks that are distinct from commercial mobile networks, and also distinct from other mission critical networks (see also Section 4.4.1); however, the technology might be modernised to enable (for instance) the use of 3GPP technologies such as LTE (see for instance Section 5.4.3). Corresponding changes to the CCS TSI would be needed. Whether this is feasible in the existing GSM-R bands (and possibly E-GSM-R bands) or would require a new band harmonised at European level would need to be studied.
 - **European support and coordination for the use of (commercial) wireless services:** The next three sub-Options reflect active European support and coordination, but assume that actual implementation rests largely with the Member States. Each of the sub-Options includes mechanisms that seek to ensure that networks, primarily commercial wireless networks in Member States that wish to do so, would deploy with sufficient coverage, reliability and robustness to meet rail operational needs. We tacitly assume that pure commercial incentives alone would be unlikely to produce the necessary service deployments. We also assume that GSM-R becomes difficult if not impossible to support after 2030, which is consistent with statements from market players.
 - **Require selected wireless network operators to deploy and operate the service:** The assumption here is that Member States would impose suitable obligations on some or all Wireless Network Operators. The obvious policy model is universal service, where the Member State designates one (or more) network operators to provide the service in each geographic portion of the national territory, using an objective procedure (e.g. a competition or auction). The Member State may compensate the network operator for the net cost that it incurs. The overall institutional structure is defined at European level, but implementation is left to the Member States.
 - **Use of Spectrum licence obligations:** Instead of a general mandate, a Member State might impose an obligation to support rail operations as a licence condition for some attractive block of spectrum.³⁴ This has somewhat the same effect as the previous Sub-Option, in that it effectively auctions off the obligation; however, the obligation entails costs that may possibly depress the value of the spectrum block in question. US experience with this approach is not altogether promising.
 - **Use of State Aid mechanisms to motivate wireless network operators to deploy and operate mission critical networks:** State Aid rules at European level once again provide for the service provider to be chosen on an objectively valid basis such as an auction, and define permissible means and levels for compensation by the Member State government.
 - **Direct European sponsorship:** These Sub-Options are associated with a far more active European role. We consider these approaches less likely, but they are included for completeness.
 - **Strong coordination:** In this Sub-Option, the European Union would directly fund and coordinate European mission-critical networks, but would still leave implementation to the Member States.
 - **European implementation (“We do it all”):** In this (perhaps unlikely) thought model, the European Union actively provides a network for mission-critical services, probably including PPDR, rail, and possibly energy.

Finding 10. We are analysing European cross-sectoral Options and Sub-Options from least active intervention to most active intervention. A range of

³⁴ The allocation, assignment and usage conditions of the band would have to be suitable for use by GSM-R, and it would have to be defined as a supported band in the CCS TSI. This does not necessarily require full, exclusive harmonisation of the band at European level.

solutions are possible, with different implications in terms of cost and ease of implementation.

Table 1. Proposed Options for European overall cross-sectoral policy.

Number	Option Name	Sub-Option Name	Policy Approach	Technical Approach
1a	Business as usual	Business fully as usual	No new policy initiatives.	GSM-R continues to be used to 2030 and beyond. Other complementary technologies also continue to be used to 2030 and beyond.
1b	Business as usual	Enhanced business as usual	Rail continues to operate over private networks that are distinct from commercial mobile networks, and also distinct from other mission critical networks; however, the technology of the private networks can be refreshed.	GSM-R usage declines, and becomes rare or non-existent after 2030. New technology is deployed, presumably forms of 3GPP/LTE, enhanced to reflect any UIC/ETSI requirements.
2a	European support and coordination for the use of (commercial) wireless services	Require wireless network operators to deploy and operate mission critical networks	E.g. revisions to the Universal Service Directive empower Member States to require MNOs to deploy and operate mission critical networks; require Member States to choose one or more providers; and enable them to compensate MNOs for the net cost.	GSM-R usage declines, and becomes rare or non-existent after 2030. Any new technology must be consistent with whatever the network operator is deploying, presumably forms of 3GPP/LTE, enhanced to reflect any UIC/ETSI requirements.
2b	European support and coordination for the use of (commercial) wireless services	Facilitate the use of Spectrum licence obligations	The Member State (NRA) would auction a new block of desirable spectrum such that the winner accepts the obligation to deploy a network with suitable coverage that can support (PPDR and) rail.	GSM-R usage declines, and becomes rare or non-existent after 2030. Advantageous to permit the technology to be consistent with whatever the MNO is deploying, presumably forms of 3GPP/LTE, enhanced to reflect any UIC/ETSI requirements.
2c	European support and coordination for the use of (commercial) wireless services	Employ State Aid mechanisms to motivate wireless network operators to deploy and operate mission critical networks	Use State Aid rules to determine a provider (e.g. by an RFP). Conditions are set by contract rather than by regulation.	GSM-R usage declines, and becomes rare or non-existent after 2030. Technical standards developed by UIC/ETSI, probably based on LTE or 5G. EU conducts a procurement to establish a list of prequalified suppliers, with discounted prices, available to the Member States.
3a	Direct European sponsorship	Strong coordination	EU funds a multi-purpose public critical services network. Member States implement the network. Those Member States that accept funding accept associated conditions. Other Member States must build (or procure commercial services) to interoperable standards, and with equal or greater quality.	GSM-R usage declines, and becomes rare or non-existent after 2030. Technical standards developed by UIC/ETSI, probably based on LTE or possibly 5G. EU conducts a procurement to establish a list of prequalified suppliers, with discounted prices, available to the Member States. MS must procure equipment that meets standards, not necessarily from the list.

3b	Direct European sponsorship	EU does it all	EU funds and implements a multi-purpose public critical services network in those Member States that accept it. Other Member States must build to interoperable standards, and with equal or greater quality.	GSM-R usage declines, and becomes rare or non-existent after 2030. EU procures equipment to technical standards developed by UIC/ETSI, probably based on LTE or possibly 5G. Equipment procurement terms offered to EU must also be offered to Member States.
----	-----------------------------	----------------	---------------------------------------------------------------------------------------------------------------------------------------------------------------------------------------------------------------	---------------------------------------------------------------------------------------------------------------------------------------------------------------------------------------------------------------------------------------------------------------

Table 2. Apparent implications of Options and Sub-Options for the approach to spectrum, and integration with commercial MNO services, PPDR, and/or energy.

Number	Sub-Option Name	Spectrum Approach ³⁵	Integration with MNOs, PPDR, ...
1a	Business fully as usual	No new spectrum allocation. E-GSM-R bands (873-876 MHz (Uplink) and 918-921 MHz (Downlink)) may also be used as extension bands for GSM-R on a national basis.	No more than today.
1b	Enhanced business as usual	Whether this is feasible in the existing GSM-R bands (and possibly E GSM R bands) or would require a new band harmonised at European level would need to be studied.	No more than today.
2a	Require network operators to deploy and operate mission critical networks	Probably no new spectrum allocation. Could operate in existing mobile bands. E-GSM-R bands (873-876 MHz (Uplink) and 918-921 MHz (Downlink)) may also be used as extension bands for GSM-R on a national basis.	Likely obligation to provide interoperable networks for PPDR and for rail, but not necessarily an obligation to integrate, nor a prohibition on the Member State choosing to operate the infrastructure itself.
2b	Facilitate the use of Spectrum licence obligations	Requires a new allocation, presumably in the 450 MHz or 700 MHz range. Should be harmonised, as much as possible, at European level.	Likely integration of PPDR and rail, with surplus capacity used for commercial services. ³⁶ No prohibition on the Member State choosing to operate the infrastructure itself.
2c	Employ State Aid mechanisms	Likely need for a new allocation, presumably in the 450 MHz or 700 MHz range. Should be harmonised, as much as possible, at European level.	Likely integration of PPDR and rail, with surplus capacity used for commercial services. ³⁷ No prohibition on the Member State choosing to operate the infrastructure itself.
3a	Strong coordination	A new harmonised band is allocated, but could be otherwise assigned in Member States that choose not to let the EU deploy. Cab equipment must in any event support the harmonised band, except perhaps in equipment that will never leave the Member State.	Common private network for PPDR, rail, and possibly energy. No prohibition on the Member State choosing to operate the infrastructure itself.

³⁵ The use of licence exempt spectrum (e.g. for Wi-Fi) and/or spectrum in other suitable 5 GHz bands for sufficiently short range applications (e.g. in stations or yards) could be considered under any of the Options.

³⁶ The spectrum license obligations would require the MNO to give first preference to mission critical services.

³⁷ For example, the spectrum licensee might use LSA/ASA arrangements (see Section 2.3.3) to sublicense momentarily unneeded spectrum to a commercial MNO.

3b	EU does it all	A new harmonised band is allocated, but could be otherwise assigned in Member States that choose not to let the EU deploy. Cab equipment must support the harmonised band, except perhaps in equipment that will never leave the Member State.	Common private network for PPDR, rail, and possibly energy. No prohibition on the Member State choosing to operate the infrastructure itself. No prohibition on the Member State choosing to operate the infrastructure itself instead of accepting the EU deployment.
----	----------------	------------------------------------------------------------------------------------------------------------------------------------------------------------------------------------------------------------------------------------------------	------------------------------------------------------------------------------------------------------------------------------------------------------------------------------------------------------------------------------------------------------------------------

The spectrum management decisions are likely to be particularly challenging. Due to rail sector requirements for interoperability and roaming, the key spectrum decisions will necessarily be made at European level rather than Member State level; however, as Table 1 and Table 2 demonstrate, these decisions are linked in complicated ways to the technological approach and the management and control model that are ultimately chosen, and also to the degree to which it is possible to integrate rail operational networks with either commercial mobile networks or with other mission critical networks. Moreover, any spectrum management decisions will need to carefully consider the risk of interference (e.g. with adjacent bands), and also opportunity costs relative to sectors for other than rail.

For these reasons, it would be premature (and also out of scope for this study) to prescribe a single, preferred spectrum management approach in this report. Those decisions need to be understood as part of the overall planning and specification process (see Section 1.5).

The European Union in general and the Commission in particular have sufficient capability to resolve these questions when they are ripe, through the Radio Spectrum Policy Plan, interaction with the RSPG, and Commission mandates to CEPT and/or ETSI.

3.4. Assessment of impacts

Visualisation of qualitative assessment of impacts is often done in tabular format as in the simplified example in Table 3.³⁸ Only fully elaborated Options that meet minimum functional requirements appear.

In such a table, the ratings that are routinely used are 0 (to denote impacts the same as those of the baseline), + (better than the baseline), ++ (much better than the baseline); or - (worse than the baseline), and -- (much worse than the baseline).³⁹

For this analysis, we note that the *process* of determining who provides service in a given Member State is important, but (at this level of analysis) not necessarily the ultimate *outcome*. For instance, whether a given Member State will ultimately choose to have a network provided by, for instance, an MNO versus an MVNO is not something that needs to be decided at overall European level a decade in advance.

Benefits and costs are cross sectoral at European level; however, the Impacts to sectors other than rail are not fully analysed, since they are somewhat outside the scope of this study.

3.4.1. Definition of criteria

These criteria were collected during the first workshop and are grouped to align them with EU impact assessment methodology.

Effectiveness

Effectiveness must consider both normal operation and operation under stress (e.g. at times of bad weather, natural or man-made disasters ...).

³⁸ European Commission (2009), "Impact Assessment Guidelines", 15 January 2009, at http://ec.europa.eu/smart-regulation/impact/commission_guidelines/docs/iag_2009_en.pdf.

³⁹ Ibid.

In our assessment, we take into account the following effectiveness criteria:

- Interoperability
- Coverage: geographical coverage of rail tracks, railway stations and tunnels
- Reliability and robustness (i.e. reliability in the face of stress)

Efficiency

Efficiency relates to achieving objectives at the lowest feasible cost. Efficiency thus reflects the (capital and operational) cost of implementing the chosen Option.

3.4.2. Qualitative assessment

Qualitative assessment is presented in this section. The assessments presented in Table 3 are tentative and directional, to the extent that they depend heavily on details of how the respective Options would be implemented. In particular, the relative merits among the different cross-sectoral approaches are not altogether clear (and may not be necessary for the current study, which is rail-specific). The thought process on which the assessments are based immediately follows the table.

Table 3: Assessment of impacts

	1. Business as usual		2. European support and coordination			3. Direct European sponsorship	
	1a. Business fully as usual	1b. Enhanced business as usual	2a. Require operators to deploy and operate	2b. Spectrum licence obligations	2c. Use of State aid	3a. Strong coordination	3b. "We do it all"
Effectiveness overall	0	0	- to 0	- to 0	- to 0	0	0
Interoperability	0	0	- to 0	- to 0	- to 0	0	0
Coverage	0	0	- to 0	- to 0	- to 0	0	0
Reliability and Robustness	0	0	- to 0	- to 0	- to 0	0	+
Efficiency overall	0	+	+	+	+	0 to +	-
Cost	0	0 to +	+	+	0	0	-

Effectiveness

- **Interoperability:** Interoperability under sub-Option 1b can be expected to be similar to that of current GSM-R networks.

Each of the Sub-Options 2a, 2b, and possibly 2c provide means under which commercial network operators would be motivated or required to provide required interoperability and coverage.

Options 3a and 3b provide somewhat greater control than exists today, and therefore might possibly result in somewhat better cross-border and roaming interoperability than with today's networks. A key question is whether such a network might reduce the tendency to use different kinds of networks for different kinds of rail lines. On balance, however, we assume that interoperability would be similar to that experienced today.

- **Coverage:** Coverage under sub-Option 1b can be expected to be similar to that of current GSM-R networks. Each of the Sub-Options 2a, 2b, and possibly 2c provide means under which commercial network operators would be motivated or required to provide required interoperability and coverage. To the extent that MNOs provide the service, their existing geographic footprint does not meet needs for rail operations (nor, for that matter, for PPDR); however, for this Sub-Option to be workable, the cost of achieving additional coverage must be funded under one of the mechanisms in Sub-

Options 2a, 2b, or 2c, and therefore represents a difference in cost rather than a difference in coverage. (If the coverage is achieved through a spectrum licence obligation as in Sub-Option 2b, then the Member State is effectively paying by accepting reduced spectrum auction proceeds rather than with a direct cash transfer.) Meanwhile, Options 3b and possibly 3a might enable greater coverage, albeit at greater cost.

- **Reliability and robustness:** Similar considerations apply as with coverage. Reliability and robustness under sub-Option 1b can be expected to be similar to that of current GSM-R networks. Reliability and robustness under Sub-Options 2a, 2b, 2c could be expected to approach or reach levels currently experienced, but only to the extent that the Member State funds the network operator to enhance its capabilities. Once again, Options 3b and possibly 3a might enable greater coverage, albeit at greater cost.

Efficiency

- **Cost:** Under Cost, we consider steady state costs, not migration or transition costs; however, the migration costs are certainly relevant to overall Efficiency.

For reasons outlined in the study SCF (2014), the cost of a cross-sectoral network based on MNO services for PPDR and rail might well be somewhat less than that of the private networks used today, even after allowing for the costs of hardening the network to provide reliability and prioritisation and after expanding its coverage. There is, however, considerable uncertainty about this claim. Their analysis was primarily relative to existing PPDR networks, and only tangentially relevant to operational rail network requirements; moreover, their analysis rests on the assumption that a various reliability, coverage, management and practical requirements can be met that, in practice, quite possibly cannot be met (see Section 1.2).

For reasons noted in Section 4.1.2, the cost of coverage for rail for a new network *whether operated by a commercial mobile network operator or as a private network* might be considerably less than the “greenfield” cost if the spectrum used is slightly below the frequency of the GSM-R bands, and if the new network can operate from existing trackside locations. This could be true for any of the sub-Options, but is especially relevant to sub-Option 1b (Enhanced business as usual).

In respects other than coverage (such as reliability and robustness), wherever a PPDR broadband network is deployed (whether as a private network or else by a commercial network operator), the incremental cost of also carrying rail operational traffic will tend to be quite low. This is so because the bandwidth demands of operational rail networks are, under the assumptions we are working with for this study (including only modest traffic growth over time), minimal (but see also the discussion in Section 1.1).

Option 1b (Enhanced business as usual) would require initial capital expenditure (CAPEX) to swap out existing trackside and cabin equipment; however this will tend to be offset by the better price-performance of newer gear thanks to so-called Moore’s Law improvements, and to generally lower operating expense (OPEX) due to increased automation of management functions. With this in mind, we assume that the total cost of ownership over time for sub-Option 1b will be no greater than current GSM-R networks, and is likely to be a bit less.

Returning to the question of migration or transition costs, Options 1a and also 1b will tend to be far less complex and far less disruptive than the other sub-Options. For this reason, we assume that a sub-Option 1b is likely to be similar in overall efficiency, all things considered, to solutions based on sharing networks with a mobile operator or with a PPDR network. A more precise comparison is not possible today – there are too many uncertainties and too little data available on the existing GSM-R networks. For that matter, transition costs cannot be estimated when not even the rough outlines of a migration plan have been worked out.

In those Sub-Options where rail operations services are operated either by a commercial network operator or by a private network operating in spectrum bands other than the current GSM-R bands, the GSM-R spectrum might eventually no longer be needed (see also the discussion of spectrum management aspects in Section 3.3.2). The spectrum in

the current GSM-R bands⁴⁰ that would eventually be freed can be viewed as a reduced opportunity cost,⁴¹ which thus reduces the net cost of network operation. Current spectrum auction results suggest that spectrum in roughly the range of the GSM-R bands has an economic value of somewhere between €0.40 and €0.80 per MHz/pop⁴², with a reasonable current value being €0.50 per MHz/pop. Taking the population of the EU as roughly 500 million, this implies reduced opportunity cost for the European Union as a whole of roughly €250 million per MHz released, or €2.5 billion for the GSM-R band as a whole. We caution, however, that spectrum release could happen at very different times in different Member States; as a result, it might be a long time before a harmonised band is available for other purposes across the European Union.

These opportunity costs should be interpreted with caution, however, because (1) the GSM-R bands might possibly be re-purposed to support a successor technology; (2) assuming that the bands are not re-purposed, the time frame until the spectrum becomes available could be quite long, perhaps 2030 or later in many Member States; (3) the spectrum would not become available at the same time in all Member States, and might be in use much longer (perhaps indefinitely) in a few Member States; and (4) there would also be demand on whatever spectrum bands were used to provide successor services to GSM-R, which means that the *net gain* in terms of opportunity cost would be correspondingly reduced. If functional requirements and bandwidth demands are largely static, as we have assumed throughout this report, then the incremental opportunity cost in a successor band are likely to be small enough to ignore, *provided that the successor band also supports some other application*; however, if substantially more bandwidth is required than is needed for GSM-R today, the net gain in terms of opportunity cost will clearly be less than the €2.5 billion estimated here.

Furthermore, a €2.5 billion savings in opportunity cost does not represent nearly as large a savings as one might initially imagine. First, it is a figure for all of Europe, which might never be fully achieved. Second, it reflects one time auction value – on an annualised basis over the typical lifetime of auctioned spectrum, it is far less. Third, it is an opportunity cost savings that does not take into account the numerous real migration costs that would be incurred in order to fully achieve it.

Finding 11. For reasons outlined in SCF (2014), the cost of a cross-sectoral network based on MNO services for PPDR and rail might well be somewhat less than that of the private networks used today, even after allowing for the costs of hardening the network to provide reliability and expanding its coverage. At the same time, it is necessary to bear in mind that their analysis was primarily relative to existing PPDR networks, and only tangentially relevant to operational rail network requirements; moreover, their analysis rests on the assumption that a various reliability, coverage, management and practical requirements can be met that, in practice, quite possibly cannot be met. Further study is needed.

Finding 12. Taking migration costs into account (which is not fully possible until far more is known about the migration) an Enhanced Business as Usual approach (with private rail networks using modernised technology) might well

⁴⁰ GSM-R share the UIC band with Defence in several Member States. Thus it is unlikely that this band could be heavily used by MFCN

⁴¹ Note that the *opportunity cost* is the cost relative to the highest valued use to which the resource (spectrum) could otherwise be applied, and is thus best reflected by the valuation implied by the price that the spectrum would fetch at auction. The opportunity cost is thus independent of any decisions as to alternative uses of the same spectrum.

⁴² F. Pujol (IDATE), Spectrum Watch Service 2014.

be comparable in efficiency to the various network sharing sub-Options that we have considered.

Finding 13. If the GSM-R bands can eventually be released, the opportunity cost for the European Union as a whole of up to roughly €2.5 billion could be freed. This number rests however on many assumptions, and must be interpreted with caution.

4. The Member State level

Key Findings

- In light of the substantial differences among the Member States, it is likely that they will reach different conclusions as to how best to proceed.
- European policy needs to recognise and accommodate the differences, but not at the cost of interfering with European goals (especially with interoperability and ability to roam with other dedicated/shared networks and commercial networks, all over Europe).
- Coverage requirements can differ greatly among different wireless applications. For rail operational networks, they differ as well as a function of speed and traffic of the lines. Stations, depots and shunting yards tend to require coverage at greater bandwidth than is needed elsewhere.
- There could be enormous value in re-use of the existing trackside GSM-R locations by a future replacement system. This does not necessarily imply that the same ownership and control model be carried forward. As long as a future successor to GSM-R were to operate in frequency bands similar to or slightly lower than the frequency band of GSM-R, and assuming no radical growth in bandwidth demands, the same route kilometres could be covered using the same sites.
- Multi-technology support has potential value. Current geosynchronous satellites are subject to substantial latency, but could nonetheless be better than lack of coverage in remote areas, and are in use for operational rail communications in other parts of the world. In the future (post 2030), use of MEO satellites to cover remote areas might bring considerable additional benefits.
- At Member State level, Options differ largely on the degree to which private networks, unmodified commercial networks, or commercial networks with modifications for mission critical services are used. Many hybrids are possible.
- At this level of analysis, it is necessary to distinguish between voice requirements and (ETCS) data requirements.

In this Chapter, we assess the decisions about rail communications to be taken at Member State level.⁴³

Under the current legal framework, Member States have only limited discretion over technology, inasmuch as only one system and only one frequency band (plus an extension band) is allowed in the CCS TSI. Nonetheless, Member State decisions are crucial in determining which lines are covered (beyond those that are mandatory), and when (consider also Section 2.2). Member States also determine the operational and control model for rail operational communications, and provide funding.

Going forward, it is likely that a future CCS TSI will allow more than one technology and more than one frequency band. This is likely to effectively further expand the decision-making power of the Member States.

Member States also make decisions about other mission critical services, including PPDR and energy. The degree to which these networks are integrated with one another is therefore likely to also be largely or entirely a Member State decision (depending somewhat, however, on the approach taken at the European cross-sectoral level, as explained in Chapter 3).

⁴³ We are taking liberties with the use of the term "Member State" here. A number of European countries that are not Member States of the EU or EEA apply the CCS TSI.

Member State decisions are not the primary focus of this study; rather, we are trying to formulate advice for rail communication decisions at European level. Nonetheless, it is clear that the choices that are likely to be interest to the Member States, some of which take into account not only rail transport but also other sectors including PPDR, set the framework within which European decisions need to be contemplated. European rail policy measures should support, or at least not make more difficult, the policies that the Member States are likely to want.

These decisions are likely to be taken at substantially different times in different Member States. The Member State decisions are likely to be taken years in the future, at a time when a great deal that is not known today about the technical evolution of commercial mobile networks has become clear. Moreover, the choices taken by the Member States might vary greatly from one Member State to the next based on valid considerations specific to each. For these reasons, it would be pointless to try to second-guess those decisions today. Nonetheless, there is a great deal that we can say about the considerations that are likely to shape those decisions.

A tacit assumption in this chapter, based on the assessment in Chapter 3, is that it is highly unlikely that the European Union will either build a massive pan-European network for rail operations, or will subsume all decision power over rail communications. We consider it far more likely that the current decision model will carry forward in some form, where the Union specifies requirements that ensure interoperability, permit roaming, and facilitate scale economies, while leaving it to the Member States to determine how best to fulfil those requirements within the national territory.

The decision-makers are Member State governments. The decision-makers span multiple sectors – these are not just rail decisions. The ministry of transport, however defined, will typically play a role, as will the rail Infrastructure Manager (IM). The Member State spectrum management authority (SMA) will typically also play a role.

We present this analysis prior to the chapter on rail communication decisions at European level (Chapter 5) because the content of this chapter largely drives the content of that chapter.

4.1. Differences in the respective positions of the Member States

The Member States differ greatly in terms of:

- The degree to which the existing GSM-R network already provides the necessary *geographical coverage* for rail operations, today and in the period up to roughly 2030;
- Largely as a consequence, the *incremental cost* that a dedicated network would require to achieve the desired coverage;
- The approach likely to be taken to mission-critical PPDR networking, and the willingness at Member State level to combine whatever approach is taken with a networking solution for rail operations.

In light of the substantial differences among the Member States, we consider it likely that they will reach different conclusions as to how best to proceed. Assuming that this is the case, European policy needs to recognise and accommodate the differences, to the extent that doing so does not interfere with European goals (especially with interoperability and ability to roam with other dedicated/shared networks and commercial networks, all over Europe).

4.1.1. Coverage requirements

Different kinds of mobile networks have very different geographical coverage requirements.

- Commercial mobile networks are generally interested in covering as much as possible of a country's *population*, since it is the subscribers who generate the revenue.

- PPDR networks will also have greater interest in dense areas than in sparse, since that is where more of the incidents occur; however, they will want to coverage of the area of the national territory as possible, since an incident could occur anywhere.⁴⁴
- For a rail operations network, it is crucial to cover all of the *route kilometres* of the rail network. At the same time, the quality of coverage could vary greatly depending on the speed of line and frequency of traffic over the line. It is already the case today that many low speed low frequency lines are covered by more limited communication services (provided e.g. by commercial MNOs)⁴⁵ rather than GSM-R.⁴⁶
- Bandwidth demand tends to be particularly great in stations, depots, and shunting yards. These locations tend to require a high volume of concurrent communications. It is for this reason that technologies operating in licence exempt spectrum (such as Wi-Fi) or in somewhat higher frequencies (e.g. 5 GHz) may be particularly useful.

The coverage needs of the European rail network are evolving only slowly over time. New high speed lines take years to build. Thus, most high speed rail lines either already have GSM-R service, or can be expected to have GSM-R service long before a transition to a successor network is required. Thus, the cost of coverage of high speed rail lines by GSM-R can be viewed for our purposes as a *sunk cost*.

Since there was no obligation to do so (before the extension of the scope of the CCS TSI in 2015), many countries have chosen not to extend GSM-R coverage to low speed, low frequency rail lines, especially in rural areas, but instead are using coverage provided by public networks and roaming (accepting reduced functionality). If countries were to choose to extend coverage (whether by means of GSM-R or of a successor technology) to lines that are not now covered by GSM-R, substantial additional investment would be required.

Finding 14. Coverage requirements can differ greatly among different wireless applications. For rail operational networks, they differ as well as a function of speed and traffic of the lines. Stations, depots and shunting yards tend to require coverage at greater bandwidth than is needed elsewhere.

4.1.2. Cost implications

GSM-R stakeholders consistently report that 80% to 90% of the capital cost of a GSM-R network is in the sites, in which they generally include not only buildings, but also masts, radio gear, back-haul arrangements, and any arrangements to ensure that an uninterrupted supply of power.⁴⁷ It should be noted that the relative cost of equipment for radio and signalling in the vehicles is very low compared to the network cost.

Given the rather static geographic coverage that is required, *there could thus be enormous value in re-use of the existing trackside GSM-R locations by a future replacement system*.

We assume here, as we have throughout, that bandwidth demand for operational rail communications is growing only slowly (see Section 2.3.2). If, however, throughput requirements were to grow, a more dense network might be needed. Depending on QoS requirements, the difference might be substantial.

Many have assumed that this would imply a continuation of the existing model of ownership and operation of GSM-R, but *this does not necessarily follow. As long as a future successor to GSM-R were to operate in frequency bands similar to or slightly lower than the frequency band of GSM-R, the same route kilometres could be covered using the same sites.*⁴⁸

⁴⁴ PPDR stakeholders express interest in covering rail routes, since they are potential areas for disasters; rail stakeholders note, however, that PPDR networks often do not cover rail lines today.

⁴⁵ This is, for example, the case in France, Italy and Switzerland.

⁴⁶ This can, however, vary greatly from one Member State to the next. In Germany, for example, commercial mobile networks reportedly cover some 99% of rail lines, and are used as a backup to GSM-R, and in lieu of GSM-R for rural lines with infrequent train movement.

⁴⁷ The ability to achieve these savings in practice will depend on various factors, including the shape of the track, base station antenna characteristics, and the absence of obstacles.

⁴⁸ A tacit assumption here, as throughout the report, is that traffic requirements are growing only slowly (see Section 1.1). If the traffic volume were to grow radically, the network design might need overall re-thinking.

Suppose, for instance, a Member State government (or its Infrastructure Manager (IM)) were to contract with an MNO to install LTE base stations, operating in the 800 MHz band, in the same locations where GSM-R operates today, using the same masts and the same reliable power arrangements. In principle, it should be possible to cover roughly the same route kilometres, since the propagation characteristics would be marginally better than those of GSM-R.

The MNO might choose to also serve public users from the same location (subject to careful arrangements to ensure that rail operations are not crowded out at times of high consumer demand and during incidents); however, service to consumers would tend to be uninteresting for long rural stretches of rail where few consumers live. As long as the network operator were serving only rail operations from the location in question, the existing back-haul arrangements would likely also be sufficient (since rail operational bandwidth requirements are at present growing very slowly if at all, as explained in Chapter 2). In some Member States today, licences for commercial spectrum include an obligation to provide coverage to areas where the commercial interest of the MNO would not otherwise lead it to provide coverage, such as railway lines.⁴⁹

If the Member State were interested in a PPDR network, similar considerations might apply. If PPDR spectrum were to become available in the 700 MHz band or in the range of 450-470 MHz (with some loss of efficiency, since more sites are deployed than are strictly needed), then once again the existing route kilometres could be served from the same locations, and the PPDR network could presumably use the same facilities to expand its own geographical coverage. Since bandwidth requirements for rail operations are minimal, there is little risk of rail operations interfering with PPDR needs; however, there is risk that PPDR traffic might interfere with rail operations traffic unless the traffic is carefully managed. The amount of spectrum needed, and also the backhaul capacity to the sites, would however need to reflect PPDR needs (which are presumably much greater than those for rail operations).

All of this implies that path dependencies play a huge role here. The position of the Member States will tend to vary based on (1) the degree to which they have already deployed GSM-R, or will have deployed it before a switch is needed; and (2) the degree to which they want or are required to support new rail lines (e.g. at lower speed or frequency) using the same infrastructure. The lowest cost alternative might be very different in one Member State than in its neighbours. This will tend to lead to different choices being taken.

Finding 15. There could be enormous value in re-use of the existing trackside GSM-R locations by a future replacement system. This does not necessarily imply that the same ownership and control model be carried forward. As long as a future successor to GSM-R were to operate in frequency bands similar to or slightly lower than the frequency band of GSM-R, and assuming no radical growth in bandwidth demands, the same route kilometres could be covered using the same sites.

4.1.3. Integration with PPDR capabilities

As noted repeatedly throughout, different Member States are likely to take different approaches to PPDR broadband networking. Some may choose to contract operation out to commercial MNOs, system integrators, or MVNOs (as the UK is currently attempting to do); others may continue to prefer dedicated PPDR networks, as is the case with TETRA and TETRAPOL.

Whatever approach is taken for PPDR broadband networking, the Member State should consider possible synergies and financial savings through joint operation with rail. The practicability of doing so, however, will vary greatly from one Member State to the next.

Whenever operational rail networks share facilities with commercial or other mission critical networks, proper prioritisation of traffic is essential (see Sections 4.4.2 and 4.4.3).

⁴⁹ There are also examples of coverage obligations for rural areas, e.g. in Germany.

4.1.4. Multi-technology networks

Work is already ongoing to provide a clean partition of function between the applications that run over GSM-R (including ETCS) and the underlying transport mechanism (see Section 5.4.1). This potentially enables multi-technology network models based upon several IP-based bearers. Various technologies such as GSM-R (GPRS/EDGE), LTE, future 5G, and satellite could be combined. In many cases, these multi-technology networks would also be hybrids, operating under more than one model of ownership and/or control. For instance, a Member State might choose to use a commercial satellite services provider to cover remote parts of the national territory served by lines with less stringent traffic requirements.

Solutions that incorporate Wi-Fi, satellite, or other technological platforms that do not include specific adaptations for mission critical services tend to pose challenges as regards (1) security (including both the integrity and the confidentiality of communications), (2) availability and robustness, and (3) ability to prioritise mission critical traffic over other traffic (see also Sections 4.4.2 and 4.4.3).

The potential benefits of multi-technology networks are manifest, but there are also costs that should not be forgotten. A more complex mix of technologies may imply increased cost for equipment suppliers. Roaming and interoperability potentially become more complex as the combinatorial complexity of configurations increases. This very likely increases the cost of certification and testing, and may possibly also have negative implications for reliability. It is thus important to avoid a needless proliferation of supported configurations (see also Section 5.4.2).

It is particularly likely that a mix of technologies will be needed during migration. Once again, it will be important to ensure that the number of supported configurations does not get out of hand, potentially ballooning costs.

Multi-technology networks are viewed in the context of our analysis not as an Option, but rather as a capability that a given Option may or may not be able to support. Multi-technology networks can, in principle, be supported under many of the Options, but not all.

Satellite

Satellite communication can be useful for bringing connectivity to remote areas which would otherwise be expensive or impractical to serve. To some extent, this is already the case today, but more so in other parts of the world than in Europe. There are two main opportunities:

- Current and future use of geosynchronous (GEO) satellites, or
- Future use of Medium Earth Orbit (MEO) satellites.

Signals transmitted by means of GEO satellites invariably experience high *latency* or delay. GEO satellites orbit the earth once per (sidereal) day, and thus appear to stay roughly stationary over a particular point on the earth. This simplifies the task of aiming an antenna at them. Such an orbit is possible only at an altitude of 35,786 km above mean sea level, which implies a round trip time for radio waves of roughly 250 milliseconds. Since this latency is a function of orbital mechanics and the speed of light, no technological enhancements can be expected to improve it.

This delay affects data services, especially delay sensitive data services such as ETCS. It does not outright prevent all voice communications, but two parties to a conversation are likely to start to speak at the same time because neither realises that the other has already begun to speak. For group calls, this could be a severe impediment.

Operational rail services depend both on voice services and, notably in the case of ETCS, data services. For satellite to be an attractive solution, it should ideally be able to support both.

The use of GEO satellites for rail operational data has been implemented in other parts of the world, and is being actively explored in Europe. The European Space Agency (ESA) is supporting the 3InSat project, an IP-based satellite scheme that is being tested in Sardinia. Based on this experience, project participants claim that GEO satellite latency can be

managed by the train control systems, especially for low traffic, regional or local lines. In the short term, use of geosynchronous satellites to cover remote parts of Europe that would otherwise be difficult to serve might bring considerable benefits. This may be particularly interesting for lines that, due to lower speed and lower density of traffic, have lower traffic demand.

Historically, Low Earth Orbit (LEO) communication satellites have often been subject to financial difficulties; nonetheless LEO communication systems such as Iridium exist, and are not subject to high latency (because they orbit much closer to the earth). ESA has expressed the view that GEO/LEO solutions could be found and deployed if the rail sector could provide clear requirements.

In the future, MEO (Medium Earth Orbit) satellite might represent a less problematic solution. MEO satellites operate closer to earth, and thus represent a better balance between on the one hand entailing much less latency, and on the other covering a substantial fraction of the earth with each MEO satellite. According to the preliminary results of the Satcom4Rail project, in the future, a possible candidate system could be a MEO satellite constellation in the C-band, but such a system could only become a reality in 2030 at the earliest. The Satcom4Rail project sees merit in MEO C-band solutions if existing satellite systems prove unable to meet rail requirements, and provided that the railway functionality remains stable

The Satcom4Rail project explores the introduction and authorisation of satellite communications in support of railway critical safety and liability applications and services. The project has a limited scope, but preliminary results from the project suggest that GEO/L-band INMARSAT (with worldwide coverage) could provide a latency (i.e. transaction time, one-way) of around 242 milliseconds, and could also be supported in handhelds (but not for safety critical communications) for narrow band applications. GEO/Ku-band (with coverage in Europe) could provide a latency of around 256 milliseconds for broadband applications, but would not be supported by handhelds.

Satellites could play a useful role in a multi-technology network, potentially not only for rail but also for PPDR⁵⁰.

Wi-Fi

Wi-Fi, as standardised by IEEE, uses unlicensed frequency bands in the 2.4 and 5 GHz frequency bands. The latest technical improvements involve wider bandwidth and the use of MIMO to boost data rates. Given the limited range of Wi-Fi systems due to the use of unlicensed frequency bands and low power; it is expected that coverage of Wi-Fi systems would be limited to train stations and their immediate environs.

Finding 16. Multi-technology support has potential value. Current geosynchronous satellites are subject to substantial latency, but could nonetheless be better than lack of coverage in remote areas, and are in use for operational rail communications in other parts of the world. In the future (post 2030), use of MEO satellites to cover remote areas might bring considerable additional benefits.

4.2. The Problem at the Member State (national) level

Within the European Union, we generally speak of the Member State level; however, it is important to remember that a number of the relevant countries here are not Member States (e.g. Switzerland).

⁵⁰ Antenna size is part of the conditions that may make the option of using satellite services successful. It should also be mentioned that satellite can also provide backhaul links between 3GPP network equipment.

In some Member States, there may be an attempt to deal with multiple mission-critical sectors in an integrated way; in others, however, different approaches are likely to emerge, e.g. keeping separated dedicated networks for each sector.

Sufficient for our purposes is to define a Problem statement at Member State level that is specific to the rail sector.

- Identify technical, spectrum management, and policy measures to be undertaken to enable continued provision of critical operational communications functionality to the rail sector within the Member State in question and in an interoperable way with the rest of Member States as technology and markets evolve going forward.

4.3. Rail-specific Objectives at Member State level

In principle, identifying Objectives is an exercise for the Member States; nonetheless, we put forward the following General Objectives for the rail-specific Problem at Member State level:

- Support all current and anticipated future mandatory rail operational functionality (including communications to and from the dispatcher, ETCS support, and Railway Emergency Call) at reasonable cost using modern, supportable technology.
- Support additional⁵¹ rail functionality (possibly including business-supporting communications)⁵² to the extent that the same mechanisms can do so at reasonable cost.

As noted in Sections 1.1 and 2.3.2, railway functional requirements appear to be evolving very slowly. The Objective of this study is not to investigate the functionality that railways may require in the far future (see also Section 1.3). Based on the conclusions of the Ex-Post Evaluation of GSM-R conducted by ERA,⁵³ there is no indication that new basic functionality for signalling and traffic operation will be required by all the railways in the close future. Therefore, the hypothesis is that only the current functionality in the CCS TSI needs to be migrated to the new systems.

Other organizations are investigating the evolution of the functionalities requested by railways. In particular, UIC, in its project “Future Railway Mobile Communication System” (FRMCS), will carry out a study on future functionality⁵⁴. The results of this study are not available at the moment of writing the current report. This study cannot yet benefit from the deliverables of the FRMCS project or of other projects.

If the hypothesis is changed, the analysis in this study may have to be reviewed.

4.4. Network Options

Broadly speaking, the Options available at Member State level can be distinguished based on the degree to which they depend on (1) networks dedicated to rail operations, (2) commercial mobile networks with few if any modifications to accommodate rail operations, or (3) networks based on commercial mobile technology (e.g. some form of LTE), but enhanced to support rail operations (and PPDR), as depicted in Figure 4.

⁵¹ In this document, for clarity, the term *mandatory* is used for items related to the CCS TSI, and the term *additional* is used for items not related to the CCS TSI. The term *optional* can be confusing, because in this document Options are used for other purposes.

⁵² Rail stakeholders are generally of the view that it is impractical to support and passenger entertainment or general communications with the same networks and technologies as train operations. Doing so would entail numerous regulatory and policy complexities, and would also require orders of magnitude more bandwidth (and thus a substantially different design) than is required for train operations.

⁵³ Wouter Malfait (2014), “Ex-Post Evaluation: Operational Requirements of Railway Radio Communication Systems”, ERA.

<http://www.era.europa.eu/Document-Register/Pages/Ex-post-Evaluation-%E2%80%93-TSI-CCS-%E2%80%93-Operational-Requirements-of-Railway-Radio.aspx>

⁵⁴ NGTC and Shift2Rail projects are to be considered

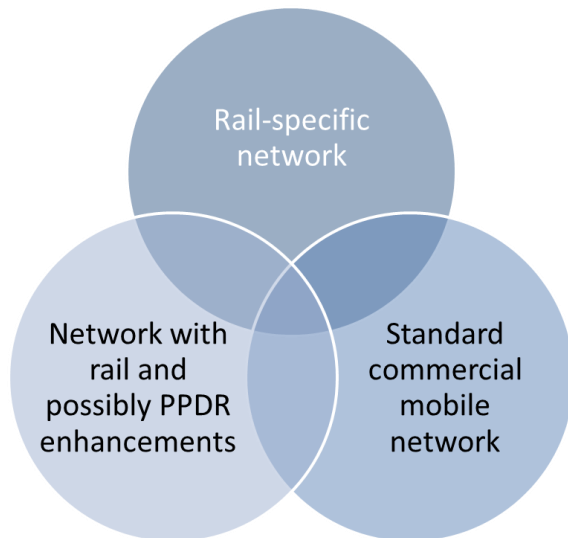
Figure 4. Main Options available to the Member States.

The “rail-specific network” might represent a GSM-R network as it might exist today, or might represent a future “GSM-R successors” network. In either case, we are talking about a solution at Member State level that is utilised solely for rail operations (and possibly some other rail functions).

The “standard commercial mobile network” is a public mobile network that does not contain special enhancements, capabilities, or “hardening” to make it particularly suitable for rail operations, e.g. an LTE network operated by a normal MNO.

The “network with rail and PPDR enhancements” might be based on the same basic technology and standards as a commercial mobile network, but includes special functionality to support functions such as rail emergency call and group calls (as might be available for instance in LTE Release 13), together with guaranteed capacity, quality of service and availability and enhanced robustness.

Somewhat in contrast to normal Impact Assessment practice, these Options cannot be viewed as being mutually exclusive.

- First, there is a relationship on the *time axis*. In all conceivable scenarios, for instance, existing GSM-R solutions will co-exist with other solutions for many years, probably until 2028 or 2030.
- Second, there will often to be an overlapping relationship in terms of *space or geography*. It is quite likely that solutions based on standard commercial mobile networks will co-exist with solutions based on, for instance, networks with enhancements to support rail and/or PPDR operations in the same Member State at the same time (with the commercial solutions used, for example, for slower speed or lower frequency lines).

These Options differ from one another chiefly in that rail operations functionality cannot depend on more network functionality than the network is capable of providing. Commercial mobile networks routinely provide only a subset of the functionality and robustness that rail operations ideally seeks (see Figure 5). To use a commercial mobile network with no special enhancements, either the rail-specific functionality must be re-architected so as to eliminate dependencies on rail-specific network enhancements, or rail must do without the respective capabilities.⁵⁵

⁵⁵ “Doing without” may be feasible depending on the traffic characteristics, but is presumably out of the question for high speed lines operating under ETCS Level 2 or later.

Figure 5. Functionality of a standard commercial mobile network versus that of a network enhanced to support rail and/or PPDR.

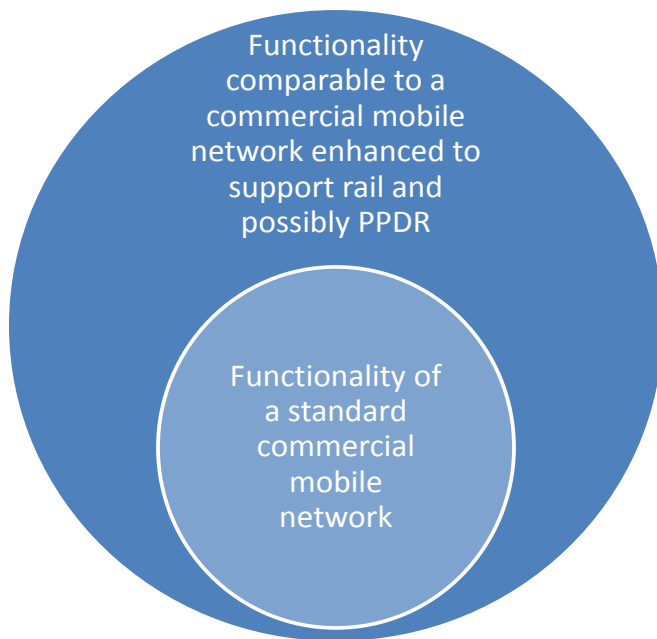

In none of these cases do we distinguish as to who owns or controls the respective network or networks. That is unimportant, as long as the Member State ensures that there are reliable assurances that committed service levels will be met. Multiple solutions already exist within Europe today.

With that said, the Options of interest are as described in the following sub-sections.

Finding 17. At Member State level, Options differ largely on the degree to which private networks, unmodified commercial networks, or commercial networks with modifications for mission critical services are use. Many hybrids are possible.

4.4.1. Rail-specific networks

In these Options, rail continues to operate single-purpose specialised networks.

GSM-R

Rail continues to use GSM-R technology. Where required, implementation of GSM-R successors can take place, providing enhancements for voice and data capacity, robustness (geo-redundant cores), resilience against interference, etc. It should be noted that GPRS / EDGE will only increase (radio channel) capacity for data traffic but not for Voice. In addition the maintainability and ability for evolution of GSM-R will decrease due to increased obsolescence of the corresponding know-how.

GSM-R successors

There is no official published standard as of now, but we assume that GSM-R successors will imply that rail evolves to use an enhanced form of transmission, that remains compatible with GSM-R or moves to a newer, already existing network technology such as LTE. It would represent an all-IP evolution of the GSM-R core and radio network, together with the

coexistence with other technologies. Applications providing railway functionality would be de-coupled as much as possible from the characteristics of the radio bearer. Applications would be de-coupled as much as possible from the characteristics of the radio bearer. In any case, GSM-R successors will have to remain interoperable with GSM-R due to the expected length of the migration time.

As far as spectrum is concerned, there will be a need to control the network and spectrum (in case specific bands are to be used and licenses owned by railways). In case spectrum is used under a LSA-type scheme, this will require strict geographical separation and coordination will be required (not excluded possibility of PPP).

The GSM-R successor operator could also be a MVNO using a combination of unmodified and/or modified commercial mobile networks and even PPDR networks. Various options could be considered depending on the equipment operated by the MVNO (core network operated by the MVNO, virtual core network provided to the GSM-R successor operator...).

The MVNO could also operate over all commercial MNOs (and this should be an obligation in their license) but it should be noted that no opportunity is foreseen for this scenario by most mobile operators.

4.4.2. Unmodified commercial mobile networks

In this Option, rail uses commercial mobile and/or satellite networks with little or no special adaptation to rail-specific needs other than commitments to cover the relevant lines.

In the most likely near term configuration, rail applications would become independent from the radio bearer level. They would operate using IMS platforms on LTE networks.⁵⁶

Traffic management would appear to represent a serious concern. At times of stress (for instance, a natural disaster), networks would tend to be overloaded with normal commercial traffic. In the absence of prioritisation mechanisms, mission critical traffic might not get through. Prioritisation between or among multiple mission critical services must also be addressed. In this Option, it is crucial not only that deployed networks have the right technical capabilities, but that network operators configure their networks to properly favour mission critical applications.

4.4.3. Networks with rail (and PPDR) enhancements

In this Option, rail would use a network based on technology beyond current GSM-R and its immediate successors, such as LTE. The network could *either* be a commercial mobile network, *or* a network dedicated to train operations and possibly including support for other mission-critical applications such as PPDR. In either case, the network would reflect extensive special adaptations to meet rail-specific (and possibly PPDR) needs, and substantial hardening of facilities, together with commitments to cover the relevant lines. Among the special adaptations needed would be traffic prioritisation and pre-emption mechanisms to favour mission critical traffic over any normal commercial traffic (see also Section 4.4.2).

In the most likely near term configurations, rail applications would become independent from the radio bearer level. They would operate using IMS platforms on LTE networks that actively support (for instance) LTE Release 12 and 13 capabilities, and that have been enhanced for reliability and robustness.⁵⁷

In a number of plausible scenarios, it might be useful to employ some form of LTE in the existing GSM-R bands (876-880 MHz (uplink) and 921-925 MHz (downlink)), either alone or else co-existing with GSM-R (see Section 5.4.3). The feasibility of doing so has not been studied.

⁵⁶ The decision to make rail applications bearer independent is in principle a European rail decision, not a Member State decision (see Section 5.4.1); however, the viability of this Member State decision depends to a significant degree on the success of that European rail sector decision.

⁵⁷ Again, the decision to make rail applications bearer independent is in principle a European rail decision, not a Member State decision; however, the viability of this Member State decision depends to a significant degree on the success of that European rail sector decision

Satellite networks would most likely serve a complementary role for low speed and/or low frequency lines (e.g. regional lines).

Enhanced commercial mobile networks

In this Option, rail uses commercial mobile networks with extensive special adaptations to meet rail-specific (and possibly PPDR) needs, together with commitments to cover the relevant lines.

Mission-critical networks

In this Option, rail uses dedicated non-commercial mobile networks (possibly together with other mission-critical sectors) with extensive special adaptations to meet rail-specific (and possibly PPDR) needs, together with commitments to cover the relevant lines.

4.4.4. Hybrid networks

In principle, many hybrid solutions are possible. The one that we have identified as being of particular interest for purposes of this study is a solution where either a rail-specific network or a network that includes rail-specific enhancements is used to cover part of the national territory, but one or more commercial mobile or satellite networks (with few or no rail-specific enhancements) are used as radio access bearer to cover portions of the national territory where railway traffic conditions permit. "Hybrid" could potentially have many different meanings. What is meant here is a solution where different parts of the national territory are covered by physically distinct networks using distinct equipment. A solution based solely on different generations of mobile switching equipment would not necessarily be hybrid in this sense, since the mobile services could probably be provided by a single network offering multiple mobile capabilities.

4.5. Assessment of impacts

4.5.1. Definition of criteria

These criteria were collected during the first workshop and are grouped to align them with EU impact assessment methodology.

Effectiveness

Effectiveness must consider both normal operation and operation under stress (e.g. at times of bad weather, natural or man-made disasters ...).

In hybrid networks, and in multi-technology networks, these criteria need to be understood in relation to each of the networks or technologies involved. The qualitative assessment that follows in Section **Error! Reference source not found.** is, to that extent, an over-simplification.

In our assessment, we take into account the following effectiveness criteria:

- Coverage: geographical coverage of rail tracks, railway stations and tunnels
- Reliability. It should be noted that on many railway lines "commercial network's reliability" is considered as sufficient.
- Robustness (i.e. reliability in the face of stress)
- Resilience to Interference. It is expected that today's situation with GSM-R (interferences from public GSM to GSM-R) is not repeated, and that obligation to be protected against interferences is imposed both at the network side (license obligation) and at the terminal side (hardened terminals).
- Latency (i.e. end to end delay across the network)
- Security: embraces both jamming of radio networks and hacking of IP-based networks. Originally the terms jamming and interferences were used interchangeably but nowadays most radio users use the term "jamming" to describe the deliberate use of

radio noise or signals in an attempt to disrupt communications (or prevent listening to broadcasts). Hacking is "Break into computer systems or software" and is increasingly being performed for intrusion in IP networks. Hacking though the increasing deployment of IP-based solutions has to be taken into account and specific measures are mandatory in order to ensure security at IP-level. The fact that railway networks are not in a closed circuit mode and are connected to the Open Internet increases risks of intrusion. It is a matter of both IP and SIP and Diameter.

- Traffic prioritisation: the selected system needs to be able to control traffic overload and manage communication priorities.
- Functionality: This criterion includes capabilities embedded in the GSM-R standard, such as functional addressing, location dependent addressing, and group call. Requirements might differ by railway line category.
- Capacity: capacity to support traffic both at the radio interface and in the network sub-system.
- Ease of use: the future communications system should be as seamless as possible ("plug and play" onboard modules).
- Ease of migration: the future solution will require both backward compatibility with existing solutions and a step-by-step migration seems to be preferable. The costs of transition are not integrated in this criterion but in the efficiency category.
- Ability to incorporate satellite and/or Wi-Fi on suitable lines

Interoperability and support for roaming are not listed as criteria because they are firm requirements for all Options. Their importance and societal value for Europe are clear.

Efficiency

The cost of network deployment and operation include migration costs as well as new network costs or renting costs. This would include both CAPEX (Capital Expenditures) and OPEX (Operational Expenditures). Various ownership and control models are possible, but these costs are typically carried by the Member State and are thus relevant here. Many of these costs are typically borne by the Member State infrastructure managers (IMs), but are effectively passed through to the railway undertakings (RUs, i.e. train operating companies) through track access charges.

In our assessment, we take into account the following efficiency criteria:

- Network CAPEX⁵⁸
- Network OPEX
- Terminal CAPEX
- Spectrum opportunity costs
- Opportunity to support other services: i.e. the ability to support commercial communications (for railways staff) and/or entertainment communications (for passengers)
- Time sequencing/lifetime: there needs to assess the time development/deployment of the new system when assessing the different solutions likely to be chosen and expected lifetime of these solutions. This criteria becomes particularly relevant when assessing new technologies in new frequency bands for instance (need to assess likely spectrum allocation timelines).

Coherence

- Legal restriction: e.g. equipment has to be owned by the IM, e.g. Railways considered as critical infrastructure with specific requirements

⁵⁸ no detailed cost analysis was requested in the ToR but cost indications are given in annex

- **Manageability:** This criterion reflects the ability to verify operator compliance with pre-defined obligations. How to measure that operators do comply with their obligations (QoS) is a strong requirement from the railways community. The services needed by the GSM-R community have to be traceable, contractable. If not, the services fail in compliancy requirements.
- **Social impacts:** this criteria takes into account possible resistance from railways telecom engineers to change to a new radio network⁵⁹ and staff competency requirements (it becomes difficult hiring experienced people in radio/IP networks and this has a direct impact of overall costs: costs of training and salary costs). However, this issue can be undermined by alternative solutions such as network sharing/outsourcing. It is likely that it will be impossible to hire staff with required GSM-R know how on the long term perspective because the technology is obsolete.
- **Certification** is not included in the table. Both terminal and network certification are critical; however, this is a general European rail issue, and is addressed in Chapter 4.5.

4.5.2. Qualitative assessment

Qualitative assessment is presented in this section for ETCS data applications and for voice applications.

Benefits and costs are to the rail sector in the Member State, as might be seen from the perspective of the Member State government. There are costs and benefits to other sectors that will surely be of interest to the Member State government, but they are not directly addressed here since they are somewhat outside the scope of this study.

ETCS data applications

For each option, we provide in the table below our evaluation of the criteria for ETCS data applications:

⁵⁹ But a stakeholder mentioned the opposite problem of people not wishing to be seen as old fashioned and out of touch with modern technology

Table 4. Qualitative assessment of various approaches at Member State level – ETCS data

	Rail-specific networks		Unmodified commercial mobile networks	Networks with rail and possibly PPDR enhancements		Hybrid networks
	GSM-R	GSM-R successors	Unmodified commercial mobile networks	Enhanced commercial mobile networks	Mission-critical networks	Hybrid networks
Effectiveness overall	0	0	-	0	+	-
Coverage	0	0	-	0	0	0
Reliability	0	0	-	0	0	-
Robustness	0	0	-	0	0	-
Resilience to Interference	0	+	+	+	+	+
Latency	0	0	?	0	0	0 to ⁻⁶⁰
Security	0	0	-	-	+	-
Traffic prioritisation	0	0	-	0 ⁶¹	0	-
Functionality	0	+	- ⁶²	+	+	-
Capacity	0	+	++	++	+	++
Ease of use	0	0	--	-	-	-
Ease of migration	0	0	-	+	+	-
Ability to incorporate satellite and/or Wi-Fi on suitable lines	0	+	0	0	+	++
Efficiency overall	0	0	+	+	0	+
Network CAPEX	0	-	++	+	-	++
Network OPEX	0	+	-	-	-	-
Terminal CAPEX	0	0	+	+	0	+
Spectrum opportunity costs	0	0	0	0	0	
Ability to support rail business services ⁶³	0	0	++	++	0	?
Ability to support railway operations/services	0	+	+	+	0	?
Time sequencing/lifetime	0	+	+	+	+	+
Coherence	0	0	-	-	-	-
Legal restriction	0	0	-	-	-	-
Manageability	0	0	--	-	-	-
Social impacts	0	0	-	-	-	-

Note: the ratings that are used are 0 (to denote impacts the same as those of the baseline), + (better than the baseline), ++ (much better than the baseline), - (worse than the baseline), and -- (much worse than the baseline).

For each of the criteria noted above, we explain our evaluation.

For a hybrid network using a private network on for instance high speed lines, and commercial mobile services and/or satellite on lines where traffic permits, the limitations of

⁶⁰ In hybrid networks, the portion of the territory covered by other means (for instance, GEO satellite) is likely to experience greater latency than portions covered by any form of mobile services.

⁶¹ Linked to current and forthcoming network neutrality laws, which may need revision.

⁶² LTE does not support high speeds today but could support up to 500 km/h if standardisation is adapted. Various capabilities in the GSM-R standards will not necessarily be supported by commercial mobile networks, nor by satellite or Wi-Fi networks in hybrid configurations.

⁶³ Support of consumer services such as entertainment is typically not allowed today.

the networks that lack special accommodations for rail or other mission critical services are relevant only to the lines where they are deployed.

Effectiveness

- Interoperability (not part of the table but added here for clarity): the flexibility of on-board equipment and the related certification process will be a key item for further investigation.
 - GSM-R successors, enhanced commercial mobile networks and mission-critical networks will
 - Commercial unmodified networks & Hybrid networks will probably present interoperability hurdles

- Coverage:

Main sources: interviews (Astrid, EIM, CER, KPN...), desk research

- GSM-R successors: same radio network provides the same coverage as GSM-R today⁶⁴
- Commercial unmodified networks are not likely to provide the same coverage as GSM-R networks unless they are paid to do so (see Chapter 3)
- Enhanced commercial mobile networks will be adapted so that coverage is at least as good as GSM-R networks
- Mission-critical networks (e.g. PPDR networks) will be adapted so that coverage is at least as good as GSM-R networks
- Hybrid networks: A hybrid network using satellite networks for remote areas could provide better coverage than GSM-R

- Reliability

Main sources: interviews with requesting stakeholders and with manufacturers, desk research

- GSM-R successors : same radio network provides the same reliability as GSM-R today
- Commercial unmodified networks are not able to provide the same reliability as GSM-R networks unless they are paid to do so (see Chapter 3)
- Enhanced commercial mobile networks will be designed so that reliability matches GSM-R networks reliability
- Mission-critical networks. No indication so far that PPDR networks plan to have a similar reliability as GSM-R. Till now, PPDR representatives claim that their target is similar to commercial networks.
- Hybrid networks: the combination of various networks with multiple providers could negatively affect reliability, and the use of commercial mobile networks raises possible concerns unless explicitly addressed

- Robustness

Main sources: interviews and SCF report, desk research

- GSM-R successors : same radio network provides the same robustness as GSM-R today
- Commercial unmodified networks are not able to provide the same robustness as GSM-R networks unless they are paid to do so (see Chapter 3)
- Enhanced commercial mobile networks will be designed so that robustness matches GSM-R networks robustness
- Mission-critical networks: no indication so far that PPDR networks plan to have a similar reliability as GSM-R. Till now, PPDR representatives claim that their target is similar to commercial networks.

⁶⁴ This is the date of start of transition.

- Hybrid networks: the combination of various networks with multiple providers could negatively affect robustness, and the use of commercial mobile networks raises possible concerns unless explicitly addressed

- Resilience to Interference:

Main sources: interviews (CER, BnetzA, ECO, TrioRail...), desk research

- We consider that the GSM-R band is subject to interference today from GSM in the adjacent band, and that other frequency bands for LTE or PPDR networks will not be affected by the same adjacent band interference. Given the experiences with GSM-R interference, future decisions on spectrum, receiver quality and coordination will take into account interferences in a better way.
- GSM-R successors: ensuring protection against interferences is considered as a basic need, so it should be better than GSM-R. Better coordination and mandatory prevention of interferences will be included as a basis for any GSM-R successor.
- Mission-critical networks: Given the experiences with GSM-R interference, future decisions on spectrum, receiver quality and coordination will take into account interferences in a better way. Mission-critical terminals must be hardened. It is not a matter of technology but of availability requirements and of network density.
- Hybrid networks: might be affected by interferences in unlicensed bands (eg. WiFi)

- Latency

Main sources: interviews, desk research

- GSM-R successors : same radio network provides the same latency as GSM-R today
- Commercial unmodified networks may provide good latency (and possibly better with LTE technology than with GSM technology), but will not necessarily provide the same latency as GSM-R networks unless they are paid to do so
- Enhanced commercial mobile networks will be designed so that latency matches GSM-R networks latency
- Mission-critical networks can provide the same latency as GSM-R networks
- Hybrid networks: the combination of various networks with multiple providers could negatively affect latency, especially if geosynchronous satellites are used for portions of the national territory, and the use of commercial mobile networks raises possible concerns unless explicitly addressed

- Security

Main sources: interviews (Astrid, Bouygues Telecom, CER, ERTMS UG, Network Rail...), desk research

- GSM-R successors: the IP network sub-system, SIP and Diameter will have to be specifically designed in order to provide the same security level as GSM-R today
- Commercial unmodified networks do not provide the same security as far as the IP/SIP/Diameter part is concerned
- Enhanced commercial mobile networks will be designed so that security matches GSM-R networks security
- Mission-critical networks will provide the same security level as GSM-R networks
- Hybrid networks: the combination of various networks with multiple providers could negatively affect security, and the use of commercial mobile networks raises possible concerns unless explicitly addressed. Wi-Fi access points are easier to hack than cellular networks.

- Traffic prioritisation⁶⁵

Main sources: interviews (ASTRID...) and SCF report, desk research

- GSM-R successors networks presumably offer traffic prioritisation
- Commercial unmodified networks will most probably not offer traffic prioritisation even though this will be technically possible; it might not be allowed due to political decisions (such as today's situation, where public networks are not allowed to treat different users in a different way).
- Enhanced commercial mobile networks will probably offer traffic prioritisation
- Mission-critical networks shall provide traffic prioritization
- Hybrid networks: the use of commercial mobile networks raises concerns unless explicitly addressed

- Functionality

Main sources: interviews with manufacturers, desk research

- GSM-R successors networks could offer the same functionalities as GSM-R networks plus higher data rates services
- Commercial unmodified networks are not likely to support GSM-R-like specific services
- Enhanced commercial mobile networks could support GSM-R-like specific services
- Mission-critical networks could provide GSM-R-like specific services
- Hybrid networks: the use of commercial mobile networks raises concerns unless explicitly addressed

- Capacity

Main sources: interviews with manufacturers, desk research

- GSM-R successors : Enhanced capacity, thanks to move to packet mode and full-IP
- Commercial unmodified networks will offer higher capacity than GSM-R networks
- Enhanced commercial mobile networks will offer higher capacity than GSM-R networks
- Mission-critical networks will offer higher capacity than GSM-R networks but are likely to operate a limited amount of spectrum compared to commercial networks
- Hybrid networks: depending on implementation, might offer higher capacity than GSM-R networks

- Ease of use

Main sources: interviews (manufacturers), desk research

- GSM-R successors : as easy to use as GSM-R networks
- Commercial unmodified networks will not support some specific railways services except if the separation of application and transport is really achieved
- Enhanced commercial mobile networks will be easy to use but not as easy to use as GSM-R because they will not be dedicated to railways
- Mission-critical networks will be easy to use but not as easy to use as GSM-R because they will not be dedicated to railways
- Hybrid networks: probably more complicated than on a single network

- Ease of migration

Main sources: interviews, SCF report, desk research

- GSM-R successors : quite easy as there will be limited modification to the radio networks

⁶⁵ Depends on interpretation of forthcoming EU legislation related to network neutrality (will operators be authorised to prioritize certain traffic flows for commercial operation?)

- Commercial unmodified networks will be easy to adapt
- Enhanced commercial mobile networks will be fully “plug and play”
- Mission-critical networks will need specific adaptations to railway needs (e.g. terminals)
- Hybrid networks: probably more complicated than on a single network
- Ability to incorporate satellite and/or Wi-Fi on suitable lines

Main sources: interviews, SCF report, desk research

- GSM-R successors will enable easy integration of satellite and/or Wi-Fi
- Commercial unmodified networks will enable easy integration of Wi-Fi but satellite integration probably more complex
- Enhanced commercial mobile networks will enable easy integration of Wi-Fi but satellite integration probably more complex
- Mission-critical networks will enable easy integration of satellite and/or Wi-Fi
- Hybrid networks will enable easier integration of satellite and/or Wi-Fi since their basic characteristic is the combination of different networks, including non 3GPP.

Efficiency

- Network CAPEX

Main sources: SCF study, interviews (Agurre...), desk research (see detailed cost figures in annex)

- GSM-R successors: limited CAPEX for implementation of an IP network sub-system. This equipment is likely to be the same as commercial GSM networks.
- Commercial unmodified networks do not require any CAPEX from the railways
- Enhanced commercial mobile networks are the best option in terms of CAPEX vs the basic features (coverage, robustness, reliability...)
- Mission-critical networks: the cost of deploying such networks depends on the frequency band used but will be supported by a third party. Areas to be covered by PPDR and railways are not the same. Who would pay for what has to be defined.
- Hybrid networks: because the solution could be tailored to line requirements, would tend to be less expensive than other solutions

- Network OPEX

Main sources: SCF study, interviews, desk research (see detailed cost figures in annex)

- GSM-R successors: are expected to bring lower OPEX than GSM-R
- Commercial unmodified networks: leasing capacity to commercial mobile operators is likely to be more expensive than GSM-R OPEX
- Enhanced commercial mobile networks: leasing capacity to commercial mobile operators is likely to be more expensive than GSM-R OPEX but broadband data services and more capacity will be available
- Mission-critical networks: leasing capacity to a PPDR operator is likely to be more expensive than GSM-R
- Hybrid networks: because the solution could be tailored to line requirements, would tend to be less expensive than other solutions

- Terminal CAPEX

Main sources: SCF study, interviews, desk research (see detailed cost figures in annex)

- GSM-R successors: cost should be close to GSM-R terminals
- Commercial unmodified networks & Enhanced commercial mobile networks: cheap terminals are available. Onboard terminals should include protection against interferences additional filtering. The cost of such a modification is negligible compared to the overall cost of the GSM-R terminal.
- Mission-critical networks: cost should be similar to GSM-R terminals

- Hybrid networks: the cost of supporting multiple technologies will raise the terminal cost

- **Spectrum opportunity costs**

Main sources: interviews with regulator stakeholders, desk research

- GSM-R successors: the same spectrum is used
- Commercial unmodified networks: no specific spectrum used
- Enhanced commercial mobile networks: no specific spectrum used
- Mission-critical networks: spectrum probably paid by the PPDR user but could also be paid by the railways or both.
- Hybrid networks: no specific spectrum used

- **Ability to support other services**

Main sources: interviews, desk research

- GSM-R successors: very limited ability to support commercial communications and restrictions in the terms of licence
- Commercial unmodified networks: already support commercial services
- Enhanced commercial mobile networks: already support commercial services
- Mission-critical networks: not designed to support commercial applications
- Hybrid networks already offer commercial services but will be a mix from different services (and service qualities)

- **Ability to support railway operations/services**

Main source: comment from SBB. Services like e.g. ready-for-departure, real-time, information about rail operation for train staff, staff disposition tools, etc. are usually built upon data bearers and require moderate to medium data-rates. Due to the lack of bandwidth of GSM-R (GPRS), today public mobile networks are often used by railway undertakers for those services.

- GSM-R successors, Commercial unmodified networks, Enhanced commercial mobile networks, Hybrid networks will have much more capacity than GSM-R
- Mission-critical networks will be a mix from different services (and service qualities)

- **Time sequencing/lifetime**

Main sources: interviews, desk research

- GSM-R successors: same as GSM-R
- Commercial unmodified networks: LTE/LTE-A networks already available and coverage is improving all over Europe
- Enhanced commercial mobile networks: LTE/LTE-A networks already available and coverage is improving all over Europe
- Mission-critical networks: broadband PPDR networks are being planned in Europe and are expected to become operational in 2020-2030 with an expected lifetime of 20+ years
- Hybrid networks are already in use by railways

Coherence

- **Legal restriction**

Main sources: interviews (regulatory and manufacturing stakeholders), desk research

- GSM-R successors: no difference with GSM-R, the network is owned by the infrastructure manager
- Commercial unmodified networks: the network is not owned by the railways infrastructure manager
- Enhanced commercial mobile networks: the network is not owned by the railways infrastructure manager

- Mission-critical networks: the network is not owned by the railways infrastructure manager
- Hybrid networks: portions of the network are not owned by the railways infrastructure manager

- **Manageability**

Main sources: interview, desk research

- GSM-R successors: no difference in network ownership as for GSM-R
- Commercial unmodified networks: IM cannot manage compliance with pre-defined obligations. Railways buy commercial capacity with no specific agreement with the network operator
- Enhanced commercial mobile networks: IM manage compliance with pre-defined obligations through a contract with the network operator
- Mission-critical networks: IM manage compliance with pre-defined obligations through a contract with the PPDR network manager
- Hybrid networks: probably more difficult than with a single, integrated network

- **Social impacts**

Main sources: interview, desk research

- GSM-R successors: limited change compared to GSM-R network
- Commercial unmodified networks: railways staff do not manage the radio network
- Enhanced commercial mobile networks: railway staff do not manage the radio network
- Mission-critical networks: railways staff do not manage the radio network
- Hybrid networks: railways staff do not manage portions of the radio network

Voice applications

For each option, we provide in the table below our evaluation of the criteria for voice applications:

Table 5. Qualitative assessment of various approaches at Member State level – Voice

	Rail-specific networks		Unmodified commercial mobile networks	Networks with rail and possibly PPDR enhancements		Hybrid networks
	GSM-R	GSM-R successors	Unmodified commercial mobile networks	Enhanced commercial mobile networks	Mission-critical networks	Hybrid networks
Effectiveness overall	0	0	-	0	+	-
Coverage	0	0	-	0	0	0
Reliability	0	0	-	0	0	-
Robustness	0	0	-	0	0	-
Resilience to Interference	0	+	+	+	+	+
Latency	0	0	?	0	0	0 to ⁻⁶⁶
Security	0	0	-	-	+	-
Traffic prioritisation	0	0	⁻⁶⁷	0	0	-
Functionality ⁶⁸	0	+	⁻⁶⁹	+	+	-
Capacity	0	+	++	++	+	++
Ease of use	0	0	--	-	-	-
Ease of migration	0	0	-	+	+	-
Efficiency overall	0	0	+	+	0	+
Network CAPEX	0	-	++	+	-	++
Network OPEX	0	+	-	-	-	-
Terminal CAPEX	0	0	+	+	0	+
Spectrum opportunity costs	0	0	+	0	0	
Ability to support rail business services ⁷⁰	0	0	+	+	+	?
Ability to support fixed/mobile services	0	+	+	+	0	0
Time sequencing/lifetime	0	+	+	+	+	+
Coherence	0	0	-	-	-	-
Legal restriction	0	0	-	-	-	-
Manageability	0	0	--	-	-	-
Social impacts	0	0	-	-	-	-

For most of the criteria noted above, our evaluation is often (but not always) the same as for ETCS data. We explain the differences in the following text:

Effectiveness

- Interoperability (not part of the table but added here for clarity): the flexibility of on-board equipment and the related certification process will be a key item for further investigation.
- Coverage:
 - Hybrid networks: satellite networks could provide better coverage than GSM-R outdoors but not indoors and Wifi networks mainly provide data services, not

⁶⁶ In hybrid networks, the portion of the territory covered by other means (for instance, GEO satellite) is likely to experience greater latency than portions covered by any form of mobile services.

⁶⁷ Linked to current and forthcoming network neutrality laws, which may need revision.

⁶⁸ Related to line categories.

⁶⁹ LTE does not support high speeds today but could support up to 500 km/h if standardisation is adapted. Various capabilities in the GSM-R standards will not necessarily be supported by commercial mobile networks, nor by satellite or Wi-Fi networks in hybrid configurations.

⁷⁰ Support for consumer services such as entertainment is typically not allowed today.

circuit-switched voice. Voice over Wifi is now becoming available and should become mainstream in the coming years.

- Reliability: same as ETCS data
- Robustness: same as ETCS data
- Resilience to Interference: same as ETCS data
- Latency: same as ETCS data but jitter is an important QoS parameter impacting the audible voice quality
 - Hybrid networks: the combination of various networks (especially satellite if GEO satellites are used) could significantly increase latency.
- Security: same as ETCS data (with the assumption that voice will be 100% IP-based)
- Traffic prioritization: there might be more “priority levels” than for ETCS data
- Functionality: same as ETCS data (with the hypothesis of all specific functionalities being in the application layer). We can expect the successor to correct the limitations of GSM-R (more efficient REC and location-dependent addressing capabilities) and to be specifically tailored to railway needs.
- Capacity: same as ETCS data (Enhanced capacity, thanks to move to packet mode and full-IP)
- Ease of use: same as ETCS data
- Ease of migration: same as ETCS data

Efficiency

- Network CAPEX: same as ETCS data
- Network OPEX: same as ETCS data
- Terminal CAPEX: same as ETCS data (cost should be close to GSM-R terminals apart for hybrid networks)
- Spectrum opportunity costs: same as ETCS data
- Ability to support other services: additional voice services are not likely to be offered to passengers
- Ability to support fixed/mobile services: With new bearer independent services, the successor of GSM-R should support a common layered architecture (transport, connectivity and application) to be used by fixed/dispatcher and mobile terminals. This will decrease costs, network complexity and increase service interoperability
 - GSM-R successors: SIP/VoIP as base enables common applications @ dispatcher and mobile terminal
 - Commercial unmodified networks and Enhanced commercial mobile networks: possible as core network should remain at railways
 - Mission-critical networks: depends on technology used
- Hybrid networks: probably not easy to implement
Time sequencing/lifetime: same as ETCS data

Coherence

- Legal restriction: same as ETCS data
- Manageability: same as ETCS data
- Social impacts: same as ETCS data

Finding 18. At this level of analysis, it is necessary to distinguish between voice requirements and (ETCS) data requirements.

5. The European rail level

Key Findings

- Key elements of the Preferred Option for European rail authorities would appear to be to add specific capabilities to the relevant specifications to enable bearer independent applications in support of a small, carefully chosen range of bearer technologies, potentially including current and future LTE; possibly Wi-Fi or successor technologies; and possibly satellite networks (for lines where conditions are suitable). When specifications are sufficiently mature, 5G will be a strong candidate for inclusion.
- The use of GPRS or EDGE to carry ETCS traffic is a positive development that is already ongoing.
- Even if Member State decisions are far in the future, a coordinated standards-based approach at European level can generate substantial benefits.

Decisions at the European rail level are the decisions that are core to the current study.

The decision-makers include European rail authorities: the European Commission (DG MOVE), with support from the European Railway Agency (ERA), the Union Internationale des Chemins de Fer (UIC), a global organisation, and other sector organisations and stakeholders. Complementary decisions may be required on the part of other European institutions (such as telecommunications decisions by DG Connect) in order to support decisions in the rail area, but they are not discussed further in this study because they depend on the selected way forward and are consequently difficult to predict.

We have structured the analysis in terms of an Impact Assessment, as with the cross-sectoral European initiatives and the Member State initiatives; in practice, however, what ought to be done seems to be fairly clear based on the results of the previous chapters. The Impact Assessment is therefore much abbreviated.

Section 5.1 provides a definition of the Problem from the perspective of European rail authorities; Section 5.2 discusses the Objectives; Section 5.3 reviews the control instruments (TSI, EIRENE, and ETCS specifications) available to European rail authorities together with the UIC; Section 5.4 discusses the elements of the Preferred Option (which is the only Option that seems to be of interest in comparison with a business as usual Option); and Section 5.5 assesses Impacts of the Preferred Option against a business as usual Option (under which no new actions to achieve a standardised approach to the evolution of GSM-R would be undertaken by European rail authorities).

5.1. The Problem at European rail level

Relative to the rail-specific decisions to be taken at European level, we suggest the following definition of the Problem:

- Identify technical, spectrum management, and policy measures to be undertaken to enable continued provision of critical operational communications functionality to the European rail sector as technology and markets evolve going forward.

For the rail-specific problem at European level, we have identified one Specific Objective to date (see also Section 5.4.1):

- Promote a clean partition of function between the applications that run over GSM-R (including ETCS) and the underlying transport mechanism in order to simplify not only the forthcoming migration, but also future migrations.

Implicit in this Problem definition is our belief that it is mandatory to solve these issues for *mission critical* train functionality, primarily for train operation. The possible ability however of the same solution to meet additional rail business requirements, or perhaps even passenger entertainment needs, is *not* a mandatory requirement; however, meeting these additional needs can be factored in as a possible price/performance optimisation.

In stating the Problem in this way, we are following the general line put forward in a previous study by Analysys Mason (2014), which observed: “Rail-sector communications fall into three categories: critical operational communications, business-supporting communications, and passenger entertainment/general communications. GSM-R is used for the first category, and, in some cases, the second category, but does not have the bandwidth to support the third.” We believe that this is not just a function of available bandwidth, but rather a result of the underlying structure of the functional requirements themselves. It is *possible*, but not *necessary*, to satisfy business support, general communication and passenger entertainment needs with the same technology that is used for train operations.

We note that the definition of mission criticality proved to be challenging in the previous study SCF (2014). In their report, “Is Commercial Cellular Suitable for Mission Critical Broadband?”, they observe: “The ‘mission critical/non-mission critical’ dichotomy is ... an oversimplification. There are many degrees of criticality.”

As in any analysis of European policy, implicit in these definitions of the respective Problems is the desire that the solution be as *effective*, *efficient*, and *coherent* (with other aspects European policy) as possible.

5.2. Rail-specific Objectives

Consistent with our approach in Section 4.3, we put forward the following General Objectives for the rail-specific Problem at European level:

- Support all current and anticipated future mandatory rail operational functionality (including communications to and from the dispatcher, ETCS support, and Railway Emergency Call) at reasonable cost using modern, supportable technology.
- Support additional⁷¹, rail functionality (possibly including business-supporting communications and passenger entertainment/general communications) to the extent that the same mechanisms can do so at reasonable cost.

5.3. Control instruments available to European rail authorities

It is helpful to begin by noting that European rail authorities have a number of well-defined control instruments available to them.

- The CCS TSI;
- Annex A, containing both EIRENE specifications and ETCS specifications.

These specifications (CCS TSI Annex A: EIRENE specifications and ETCS specifications) represent a good basis for the definition of future solutions, accommodating those configurations that, based on the analysis in Chapters 3 and 4, make sense and are likely to be desired by multiple Member States. Further revision and expansion will be needed, according the applicable change management processes.

This represents something of a shift from the current structure of these documents. In practice, significant variation exists within the Member States, especially between high

⁷¹ In this document, for clarity, the term *mandatory* is used for items related to the CCS TSI, and the term *additional* is used for items not related to the CCS TSI. The term *optional* can be confusing, because in this document Options are used for other purposes.

speed lines versus lower speed lower frequency lines; however, in principle, there is only a single set of standards today, based on GSM-R.

Going forward, the same rail operations applications must be able to operate not only over current GSM-R, but over other technologies as well (implying replacement not only of software, but in many cases of hardware as well). On the one hand, this implies changes to the applications themselves to reduce or alter their dependence on the underlying network; on the other hand, it means that a (presumably small) number of network configurations must be documented as supported configurations in order to ensure interoperability, to enable rolling stock to roam, and to achieve economies of scale.

In this chapter, we identify the nature of changes that are required to the specifications; however, we refrain from indicating how this is best achieved within the existing specifications (for example, by means of separate documents per configuration versus separate chapters within existing documents). Those decisions are best taken by the subject matter experts who routinely maintain the relevant specifications.

5.4. Elements of the Preferred Option

In an Impact Assessment, one would generally define multiple Options. In this case, however, it is fairly clear based on the results of the previous chapters what ought to be done. In the interest of readability and brevity, we will leap ahead to the fairly obvious conclusions.

Under the Preferred Option, European specifications (in CCS TSI) would be revised to permit or require, in suitable configurations:

- Bearer independent applications capable of operating over a range of bearer technologies, potentially including:
 - current mobile data technology based on GPRS or EDGE;
 - current and future LTE;
 - possibly Wi-Fi or successor technologies; and
 - possibly satellite networks (for lines where conditions are suitable).

A number of additional technologies, especially 5G mobile technology, are identified as future candidates for inclusion, and a number of areas are identified as candidates for further study.

In Section 5.5, we compare the Impacts of taking this Option to those of the “business as usual” Option where European rail authorities take no new actions to promote the future evolution of GSM-R.

Finding 19. Key elements of the Preferred Option for European rail authorities would appear to be to add specific capabilities to the relevant specifications to enable bearer independent applications in support of a small, carefully chosen range of bearer technologies, potentially including current and future LTE; possibly Wi-Fi or successor technologies; and possibly satellite networks (for lines where conditions are suitable). When specifications are sufficiently mature, 5G will be a strong candidate for inclusion.

5.4.1. Bearer independent applications in support of a range of bearer technologies

The GSM-R user community is strongly of the view that the specifications need a serious overhaul in order to ensure that the rail operations applications that operate above GSM-R are fully de-coupled from its underlying transport. This is not the case today. The perceived

need was clearly visible in both of the workshops that we have conducted to date, and also in the Analysys Mason (2014) study.

We believe that this perception on the part of the GSM-R user community is sound. Decoupling the rail applications from the corresponding radio transmission bearer is necessary, not only to enable the evolution of the system to a GSM-R successor circa 2030, but also to facilitate any subsequent technological evolution that might prove to be required. It is also facilitates cross-sectoral sharing of the network.⁷²

Bearer independence cannot mean that every Member State or IM freely chooses its bearer, since that would impact interoperability; rather, it means that the CCS TSI would specify a small number of permissible bearers, and the Member State would be free to choose among them.

Stakeholders note that, while this change is necessary, it is by no means simple. The change requires a new architecture of the communications stack on-board and trackside, and a re-assignment of functions between ETCS application and the communications portion at the specification level, to allow the use of different radio transmission bearers while keeping the end application stable.

Our focus in this section is on data applications, but similar considerations apply to voice services used for rail operations. As the transmission becomes a pure IP-based substrate, bearer independence for rail operational voice communications becomes equally important. We return to this point in Section 5.4.4.

Ease of use considerations, especially during a transitional period, suggest that the user interface (e.g. to the user in the cab) should change as little as possible – ideally, not at all – as a function of the radio bearer system that is used, and also should not diverge more than is strictly necessary from the user interface that is already in place today (or failing this should provide a compatibility mode).

Feedback from the user community made clear that a migration of rail applications to the Internet Protocol (IP) is viewed as the most promising direction by far; however, this also implies potentially opening new security exposure, and support for multiple configurations may also complicate the certification of future rail operational systems. Once again, we believe that the user community has reached sound conclusions – the migration to IP is clearly appropriate, even though it introduces technical challenges that will have to be addressed.

Work along these lines has already begun as part of the GSM-R successors initiative. GSM-R successors would be an all-IP evolution of the GSM-R standard. Applications would be decoupled from the characteristics of radio bearer.

This decoupling clearly needs to progress.

Recommendation 1. The relevant specifications need a serious overhaul in order to ensure that the rail operational functionality that operates above GSM-R is properly de-coupled from its underlying transport and is future proof.

Closely linked to this assessment is our belief that this de-coupling must be effective, not only for ETCS and other data applications, but also for voice applications. Will the work that has already been initiated fully address whatever would be needed to fully de-couple voice applications such as Rail Emergency Call and Group Calls? In particular, to what degree is it feasible to duplicate GSM-R functionality in a commercial mobile (or satellite or Wi-Fi) network that does not include support for capabilities such as ProSe or GCSE? (We would also note that the fact that the capabilities show up in LTE *standards* does not necessarily

⁷² Even where different sectors share the bearer services, they might still each require distinct services or applications, and might each have distinct requirements for availability and/or Quality of Service (QoS).

mean that they will show up in *infrastructure equipment* or in *deployed commercial mobile networks*.)

GCSE itself does not represent a group call facility; rather, it represents network support, based on which network application servers and clients could implement the requisite functionality.

The question that we would raise here is, once the applications have been de-coupled from the underlying bearer service, to what degree is it possible to replicate functions such as Rail Emergency Call and Group Call with a “lowest common denominator” network that contains no special support for these features? Some functions that are performed in the GSM-R network today would presumably have to be managed by the application (or done without) if voice communications are operating over Wi-Fi or satellite.

A detailed technical study is well beyond the scope of the current project, but we consider it an appropriate action to be undertaken by ERA and standardisation bodies like UIC, ETSI, 3GPP and IEEE.

Recommendation 2. ERA and the European rail sector should study the degree to which necessary rail voice communications functionality could be provided by a “lowest common denominator” network (such as a purely IP-based radio network) that contains no special support at all for rail-specific voice communications functionality such as Rail Emergency Call and Group Call. (Application and end-to-end performance and reliability requirements might still be relevant.)

5.4.2. Cost, certification, and the number of supported configurations

Over the course of the study, differing views were expressed as to the number of technical configurations that could and should be supported. Some Infrastructure Managers expressed a preference for maximum flexibility, and for a large number of supported configurations; some equipment suppliers expressed concerns over implementation and support costs if more than a very few configurations are supported.

We believe that there is merit in both views.

Technology has evolved in ways that make a more diverse use of technology possible. The cost today of supporting more than one technology is far less than was the case ten or more years ago. With current technology, it is no longer necessary to implement a one size fits all, monolithic standard as a successor to GSM-R.

At the same time, there are clear limits to the number of configurations that should be supported and supportable. As the number of supported configurations grows, the mix and match combinatorial problem between trackside infrastructure and cab equipment grows more rapidly, which implies that the complexity of ensuring that all equipment can interoperate and roam on all relevant tracks grows exponentially.⁷³

Throughout the study, stakeholders reminded us of the need to take the cost and complexity of certification into account, both for equipment and at network level. Our belief is that certification costs are likely to increase at a more-than-linear rate as the number of supported configurations grows. This also suggests that there are practical upper limits on the number of configurations that should be supported by a successor to GSM-R.

⁷³ Roughly speaking, the number of *combinations* of trackside and cab equipment grows as the *square* of the number of supported configurations, i.e. it grows much more rapidly.

Recommendation 3. A successor to GSM-R could support more permissible configurations than are possible today, but care must be taken to ensure that the number of supported configurations is no greater than is truly necessary, sustainable, and regularly reviewed.

It goes without saying that continued interoperability with GSM-R, however defined, will continue to be a requirement for many years, presumably until at least 2030.

Recommendation 4. As new bearers are introduced, continued interoperability with GSM-R as deployed must be maintained.

It is clear that certification costs will be higher under a new, more flexible standard than they are under GSM-R. Moreover, given the importance of interoperability and roaming, there should be a strong European interest in ensuring that certification is done consistently across the Member States.

Stakeholders told us that a change in the communications configuration often required re-certification of the entire train. This might be appropriate for *large* changes, however defined, but there would seem to be an argument for a more flexible and granular certification system going forward.

In theory, certification of equipment takes place at European level; in practice, however, there are often national specificities, and it is often necessary for a change to be certified in multiple Member States for those trains that roam. This is a cost today, and can be expected to represent a greater cost going forward as the number of configurations increases.

With these considerations in mind, there is a clear need in our view to take a fresh look at the certification of operational rail communications equipment at European level.⁷⁴ A more granular and flexible certification of rail communications equipment would appear to be in order, and there should be as few national specificities as possible, ideally none at all.⁷⁵

The details are well beyond the scope of the current study, but the need seems to be clear.

Recommendation 5. ERA and the European rail sector should consider carefully European certification requirements for operational rail communications. A more granular and flexible certification of operational rail communications equipment would appear to be in order. There should be as few national specificities in the systems as possible (ideally none at all) with the goals of achieving a single certificate in Europe and thereby optimising costs.

5.4.3. 3GPP Release 12, Release 13, and subsequent releases

Rail operational standards will need to track the continuing evolution of mobile technology. The following provides a rough indication of the path that we anticipate in Europe.

It seems too early to already define commercial lifetime for each 3GPP releases. The real question is which 3GPP release of LTE will be the last one broadly implemented and how long it will be supported. The following table gives precise figures for 3GPP work and our expectation for commercial availability.

⁷⁴ Comparison with other transportation sectors might well be fruitful. Our sense is that the process of European level harmonisation of certification of airplanes is more advanced than that of trains. See for instance EASA, "Aircraft Certification", at <https://www.easa.europa.eu/easa-and-you/key-topics/aircraft-certification>.

⁷⁵ This possibility was raised at the stakeholder meeting in Lille on 11 February 2015. Our sense is that the idea was strongly supported by stakeholders.

Table 6. Anticipated evolution and deployment of mobile standards in Europe.

Commercial name	3GPP Release	3GPP start date	3GPP freeze date	Commercial availability from	Expected commercial lifetime
LTE	release 12	2012	March 2015	2016-2018	2016-2031
LTE	release 13	2013	March 2016	2017-2019	2017-2032
LTE	release 14	2015?	2017?	2018-2020	2018-2033
5G	?	2016?	2018-2019?	2020-2022	2020-2035

Source: IDATE

Planning for fifth generation (5G) mobile is significantly intertwined with that of LTE. It is possible that 5G will be based on LTE technology, at least for frequencies below 6 GHz.

A number of capabilities (notably *Proximity Service (ProSe)* and *Group Communications Service Enablers (GCSE)*) are reflected in Release 12 in support of the PPDR community. A number of these enhancements could potentially be directly relevant to rail operations; however, there are gaps in what has been developed to date, which are not expected to be closed until Release 13. These capabilities could provide a basis for capabilities such as Rail Emergency Calls and Group Calls that are routine within GSM-R today.⁷⁶

Our understanding is that operational rail communications experts have to date had little or no involvement in the relevant 3GPP SA6 standards activities. This runs the risk that 3GPP standards might emerge that do not fully address operational rail communications needs, both in terms of bearer-independence and in terms of the needs of specific applications.

Recommendation 6. The rail sector would be well advised to ensure that rail communications experts participate in 3GPP SA6 standards activities in order to ensure that these potentially crucial standards fully and appropriately address rail communications needs.

Based on what is known today, we believe that work should begin soon on developing specifications to enable migration of GSM-R capabilities to LTE networks that support these capabilities.

So far as we can see, the technical specifications need not distinguish as to whether the capabilities are provided by an enhanced commercial network, versus a network dedicated to rail applications, versus a network shared with PPDR. Instead, the specifications could be drafted in terms of the technical capabilities that the network must be able to support.

Reliability / robustness should also be specified.

The specification would presumably include a small number of supported spectrum bands, possibly including not only licensed bands but also unlicensed. For reasons indicated in Chapter 4, there are good reasons for these bands to include any LTE-relevant bands that are slightly lower than the current GSM-R band in frequency (e.g. 800 MHz, eventually 700 MHz, and 450 – 470 MHz in the event that it becomes realistically available), so as to facilitate the use of existing GSM-R sites.

Stakeholder feedback has strongly favoured a release-independent approach to standardisation of LTE as one of several successors to current GSM-R. Stakeholders note that Releases 12 and 13 are both likely to be obsolescent by 2030, the date at which we assume that GSM-based solutions are no longer supportable. The same may well be true for

⁷⁶ In comments on this study, representatives of the PPDR community expressed willingness to “collaborate with ERA/UIC to ensure that any future rail-specific functionality is considered” in this standards work.

Release 14. We agree with these views; at the same time, we consider it likely that the standards will have to deal with the degree to which an LTE network contains special support for capabilities such as Rail Emergency Calls and Group Calls.

Recommendation 7. Planning should begin incorporating 3GPP LTE-based standardised solutions into a successor to GSM-R. This should be done, as much as possible, in a manner that is independent of specific LTE releases.

Some stakeholders expressed interest in using the existing GSM-R bands as a transition mechanism, and specifically in the use of LTE in these bands. This is an interesting idea, but may have implications in terms of interference and interoperability. The extended GSM-R bands might conceivably also be of interest.

Recommendation 8. ERA should consider initiating a study on the use of 3GPP LTE in the existing 4 MHz GSM-R uplink and downlink bands, and possible coexistence with GSM-R in the band. The possible role and relevance (if any) of the E-GSM-R extension bands (873-876 MHz (Uplink) and 918-921 MHz (Downlink)) should also be reviewed at that time.

5.4.4. Current mobile technology: EDGE, UMTS/3G, and LTE

Work is already ongoing to adapt ETCS to operate over EDGE. This allows the use of the existing GSM-R infrastructure, providing a backwards compatible option for IP applications with a data rate greater than that available when transmitting data over circuit switched GSM-R.

Current mobile networks are already used in support of rail operations, especially for lower speed and/or low frequency lines (e.g. in France and Switzerland).

ETCS over EDGE is already important in light of capacity limitations in GSM-R. Since work on ETCS over EDGE is already ongoing, we assume that no additional actions are needed, and therefore make no explicit recommendations.

Finding 20. The use of GPRS or EDGE to carry ETCS traffic is a positive development that is already ongoing.

Stakeholders have made clear that 3G / UMTS is of little or no interest. It is already on the way to obsolescence, and offers less data capability than LTE. Most experts anticipate that 3G / UMTS will be switched off sooner than 2G / GSM.

5.4.5. Evolution to 5G mobile services

The evolution of new 5G mobile services is felt to be an important development for Europe. At the moment, however, there is enormous uncertainty as to what will constitute 5G. Real specifications work has not even begun yet (see Table 6).

As of today, we do not advocate an active effort to specify how GSM-R services might operate over 5G. First, it is much too early – the uncertainty as to what might constitute 5G is too great. As a related matter, it is not yet clear whether 5G will offer meaningful advantages over LTE in the medium term, given that rail operational bandwidth demands are modest and not yet demonstrably growing much over time.

If 5G were to develop as many expect, providing seamless “HetNet” integration between licensed and unlicensed spectrum, mobile and Wi-Fi, then incorporating 5G into the mix is likely to be appropriate.⁷⁷ Even though it is too early for standards work to explicitly accommodate 5G, it is important to monitor its evolution, and rail standards work should not needlessly preclude its eventual use.

The regulation / specification work should enable a late choice of the radio technology by ensuring the independence of the railway application layer.

Recommendation 9. ERA and the European rail sector should monitor the evolution of radio technologies, such as 5G mobile services, and should consider incorporating support into a successor to GSM-R once the standards are sufficiently mature.

5.4.6. Satellite networks

As noted in Section 4.1.4, satellite could provide an effective means of coverage (for lines where traffic conditions are suitable) for remote parts of the national territory. Doing so would require extending existing specifications to permit suitable configurations. This appears in our view to be warranted.

Full de-coupling of applications from the underlying bearer would need to be required (see Section 5.4.1), and the implications for voice should be considered carefully. If geosynchronous (GEO) satellites were used, the long inherent round trip delay would be obvious, both for data and for voice.

The railway application layer should remain independent from the RAN used and from how the core network is implemented. All this doesn't exclude the use of a commercial mobile network or a satellite link along rural lines where a best-effort solution is acceptable for the railway voice communications.

Recommendation 10. The ERA, the European Space Agency (ESA), and the European rail sector should continue to study the degree to which the use of satellite is feasible and practical for operational rail communications. Current GEO (and possibly LEO) satellites might possibly be acceptable for lines in remote areas with suitable traffic characteristics. Future MEO satellites are likely to have still greater applicability.

5.4.7. Wi-Fi networks

Rail stakeholders have expressed a strong interest in being able to operate a successor to GSM-R over Wi-Fi (or a successor to Wi-Fi).

Assuming that GSM-R applications evolve to a pure or nearly pure IP service (see Section 5.4.1), technical issues should be straightforward. Further, the incremental cost of adding Wi-Fi support to cab equipment is likely to be quite low.

We note, however, that expected coverage of Wi-Fi systems would probably be limited to train stations and shunting yards in light of the limited range of Wi-Fi systems (due to the use of unlicensed frequency bands and low power). With that in mind, whether the effort of incorporating Wi-Fi or successors into future revisions of the specifications for a successor to GSM-R is warranted requires thought and study. As noted in Section 5.4.2, we consider it

⁷⁷ In a sense, 5G would be part of the planning in any case, due to its close relationship to LTE. It is expected that 5G may initially rely on LTE coverage for frequency bands below 6 GHz.

important that new configurations are not introduced into successor standards to GSM-R unless their inclusion is clearly warranted.⁷⁸

Our belief is that the real benefits of Wi-Fi support flow, not from coverage requirements, but rather from capacity requirements in stations and especially in shunting yards. Communications traffic can be high in stations and shunting yards – in the Workshops, stakeholders from Switzerland and Germany indicated that GSM-R capacity constraints in shunting yards are already severe. A limited distance bearer technology such as Wi-Fi would appear to offer considerable promise as a means of alleviating congestion.

In order to obtain economies of scale in regard to the chipsets used by suppliers of rail communications equipment to implement Wi-Fi, it would presumably need to operate in the same licence-exempt bands that are used today. This means that the risk of interference with consumer Wi-Fi would need to be assessed. This is probably not a major concern for shunting yards, but could be a concern if Wi-Fi is used in train stations.

A range of technical considerations would need to be taken into account, including (1) lack of network traffic management capabilities in Wi-Fi, (2) lack of standardised hand-off from one Wi-Fi hotspot to the next, and (3) absence of new 3GPP capabilities that might possibly be used to support Rail Emergency Call and Group Call.

The time frame of the overall migration would also need to be considered once a migration plan is further along. Once other high capacity solutions are introduced (e.g. based on LTE), the capacity constraint in shunting yards will presumably be mitigated in a different way. The migration plan is beyond the scope of the current study.

Recommendation 11. ERA and the European rail sector should consider whether the inclusion of Wi-Fi (and/or some other low bandwidth optimised radio bearer) into standards for a successor to GSM-R is warranted. The prime motivations to do so would be to increase capacity in train stations and shunting yards, and also to reduce the cost of communication infrastructures. Coexistence with consumer Wi-Fi would need to be assessed, as well as the planned migration schedule to successors to today's GSM-R.

5.5. Assessment of Impacts

The detailed impacts will depend on myriad decisions; however, it is fairly clear that a failure on the part of European rail authorities to expand specifications so as to accommodate a practical evolution of the GSM-R system will result in a proliferation of inconsistent and possibly non-interoperable solutions at Member State level, thus reducing interoperability, ability to roam, and economies of scale at European level.

5.5.1. Definition of criteria

These criteria are specific to the activities of rail authorities at European level.

Effectiveness

Effectiveness at this level is largely a function of the degree to interoperability and roaming of trains among the Member States, where required, is enabled; and of the ease of migration to accommodate new functional requirements and/or new technology, both during the transition period to a successor to GSM-R, and during future transitions.

⁷⁸ Ultra-narrow band (UNB) is an emerging technology that might conceivably represent an interesting alternative to Wi-Fi. It is said to be suitable for low data volumes at longer distances than Wi-Fi. Any technology with such properties could be of interest.

Efficiency

Efficiency reflects the likely cost of migration, and the likely unit costs of future infrastructure and equipment.

5.5.2. Qualitative assessment

Qualitative assessment is straightforward. Benefits and costs are to the European rail sector, as seen from the perspective of European rail authorities.

Table 7: Qualitative assessment of various approaches at European rail level

	Business as usual	Preferred Option
Effectiveness overall	0	++
Future interoperability	0	++
Ease of migration	0	+
Efficiency overall	0	+
Cost of migration	0	+
Future equipment costs	0	+

The ratings that are used are 0 (to denote impacts the same as those of the baseline), + (better than the baseline), ++ (much better than the baseline), - (worse than the baseline), and -- (much worse than the baseline).

Effectiveness

- Future interoperability:
 - Business as usual: Interoperability today is excellent, but GSM-R is unlikely to be fully sustainable after roughly 2030. In the absence of concrete European-level initiatives and coordination, Member States would effectively be forced to find their own solutions to the long term challenge of finding GSM-R successors. This would with high likelihood lead to a proliferation of different solutions at Member State level. The likelihood that these different solutions would all be fully interoperable with one another, in the absence of active efforts at European level, to ensure that it is so, is very low. For this reason, it is highly likely that a pure “business as usual” approach with no significant extensions to existing standards for operational rail communications would lead to a significant deterioration in interoperability (for instance, would limit the ability of trains to roam, and would increase the need for bilateral negotiations [a form of economic transaction costs] between IMs in nearby Member States) in the future.
 - The preferred Option establishes specifications to ensure interoperability. These could be backed up with enforcement capabilities at European level at least as good as those that exist today. This is greatly preferable, in our view, to the likely evolution under the “business as usual” scenario. We consider this to represent a major argument for continued efforts at European level to ensure an orderly and fully interoperable transition to a successor (or small number of successors) to GSM-R.
- Ease of migration
 - If GSM-R were maintainable forever, there would be no migration costs or complexity in the Business as Usual case; this, however, is not the case.
 - In the absence of coordinated European standards, Member State decisions on the approach, even where decisions are common, could lead to lack of coordination as to the time frames in which migration is undertaken, or the intermediate steps taken to ensure interoperability during a transition.
 - A standards-based approach at European level enables systematic migration of roadside equipment and cabin equipment.

Efficiency

- Cost of migration

- The cost of migration is likely to be substantially higher in the absence of coordination of standards at European level due to transaction costs among the Member States (i.e. the need for bilateral coordination among each pair of interconnected Member States).
- Under a fully standards-based migration, transaction costs are reduced. Coordination among the Member States is simplified. Equipment supporting several of the supported configurations is likely to emerge, thus facilitating an orderly and seamless transition.
- Future equipment costs
 - Under a business as usual scenario, approaches are likely to proliferate, which would work at cross purposes with achieving manufacturing economies of scale in both trackside and cabin equipment.
 - Under the Preferred Option, a number of well-defined configurations can emerge, enabling economies of scale and thus lowering unit costs both for trackside and for cabin equipment.

Finding 21. Even if Member State decisions are far in the future, a coordinated standards-based approach at European level can generate substantial benefits.

6. Findings and recommendations

Here we provide a list and index of our findings (Section 6.1) and recommendations (Section 6.2).

6.1. Findings

Our Findings are as follows. The page on which the finding is explained appears to the right.

- | | |
|----------------------------------------------------------------------------------------------------------------------------------------------------------------------------------------------------------------------------------------------------------------------------------------------------------------------------------------------------------------------------------------------------------------------------------------------------------------------------------------------------------------------------------------------------------------------------------------------------------------------------------------------------------------------------------------------------------------------------------------------|----|
| Finding 1. The need for a successor to GSM-R is motivated by anticipated eventual obsolescence of GSM, capacity limitations in GSM-R, and a desire to reduce costs. Previous studies have found that functional requirements and bandwidth demand are evolving only slowly; however, not all stakeholders agree. | 14 |
| Finding 2. Multiple studies have assessed possible ways forward for operational rail communications (and for other mission critical networks)..... | 15 |
| Finding 3. It is exceedingly difficult to express clear, non-overlapping Options with which to address this Problem. | 20 |
| Finding 4. We find it useful to distinguish among three interrelated sets of decisions: (1) A cross-sectoral decision at European level as to how to handle PPDR, energy, intelligent highway transport, and rail communications overall; (2) a rail-specific decision; and (3) Member State (national) decisions. | 21 |
| Finding 5. Public Protection and Disaster Relief (PPDR) forces hope to upgrade their communications capabilities using broadband technology. | 22 |
| Finding 6. Needs for the energy sector are driven primarily by smart metering and smart grid applications; these have, however, different network implications. | 22 |
| Finding 7. Railway functional requirements for train operational communications have been found in previous studies to be evolving only slowly; however, needs may increase in the medium-far future. | 23 |
| Finding 8. There are commonalities between rail and other mission-critical applications for voice and data radio services, but also important differences such as speed. | 23 |
| Finding 9. Technology is evolving in ways that provide many new opportunities going forward. | 24 |
| Finding 10. We are analysing European cross-sectoral Options and Sub-Options from least active intervention to most active intervention. A range of solutions are possible, with different implications in terms of cost and ease of implementation. | 28 |
| Finding 11. For reasons outlined in SCF (2014), the cost of a cross-sectoral network based on MNO services for PPDR and rail might well be somewhat less than that of the private networks used today, even after allowing for the costs of hardening the network to provide reliability and expanding its coverage. At the same time, it is necessary to bear in mind that their analysis was primarily relative to existing PPDR networks, and only tangentially relevant to operational rail network requirements; moreover, their analysis rests on the assumption that a various reliability, coverage, management and practical requirements can be met that, in practice, quite possibly cannot be met. Further study is needed. | 35 |
| Finding 12. Taking migration costs into account (which is not fully possible until far more is known about the migration) an Enhanced Business as Usual approach (with private rail networks using modernised technology) might well be comparable in efficiency to the various network sharing sub-Options that we have considered. | 35 |
| Finding 13. If the GSM-R bands can eventually be released, the opportunity cost for the European Union as a whole of up to roughly €2.5 billion could be freed. This number rests however on many assumptions, and must be interpreted with caution. | 36 |
| Finding 14. Coverage requirements can differ greatly among different wireless applications. For rail operational networks, they differ as well as a function of speed and traffic of the lines. | |

	Stations, depots and shunting yards tend to require coverage at greater bandwidth than is needed elsewhere.....	39
Finding 15.	There could be enormous value in re-use of the existing trackside GSM-R locations by a future replacement system. This does not necessarily imply that the same ownership and control model be carried forward. As long as a future successor to GSM-R were to operate in frequency bands similar to or slightly lower than the frequency band of GSM-R, and assuming no radical growth in bandwidth demands, the same route kilometres could be covered using the same sites.....	40
Finding 16.	Multi-technology support has potential value. Current geosynchronous satellites are subject to substantial latency, but could nonetheless be better than lack of coverage in remote areas, and are in use for operational rail communications in other parts of the world. In the future (post 2030), use of MEO satellites to cover remote areas might bring considerable additional benefits.....	42
Finding 17.	At Member State level, Options differ largely on the degree to which private networks, unmodified commercial networks, or commercial networks with modifications for mission critical services are use. Many hybrids are possible.....	45
Finding 18.	At this level of analysis, it is necessary to distinguish between voice requirements and (ETCS) data requirements.....	58
Finding 19.	Key elements of the Preferred Option for European rail authorities would appear to be to add specific capabilities to the relevant specifications to enable bearer independent applications in support of a small, carefully chosen range of bearer technologies, potentially including current and future LTE; possibly Wi-Fi or successor technologies; and possibly satellite networks (for lines where conditions are suitable). When specifications are sufficiently mature, 5G will be a strong candidate for inclusion.....	61
Finding 20.	The use of GPRS or EDGE to carry ETCS traffic is a positive development that is already ongoing.....	66
Finding 21.	Even if Member State decisions are far in the future, a coordinated standards-based approach at European level can generate substantial benefits.....	70

6.2. Recommendations to the ERA and the European rail sector

Based on our analysis, our recommendations to the ERA and to the European rail sector are as follows. The page on which the recommendation is explained appears to the right.

Recommendation 1.	The relevant specifications need a serious overhaul in order to ensure that the rail operational functionality that operates above GSM-R is properly de-coupled from its underlying transport and is future proof.....	62
Recommendation 2.	ERA and the European rail sector should study the degree to which necessary rail voice communications functionality could be provided by a “lowest common denominator” network (such as a purely IP-based radio network) that contains no special support at all for rail-specific voice communications functionality such as Rail Emergency Call and Group Call. (Application and end-to-end performance and reliability requirements might still be relevant.).....	63
Recommendation 3.	A successor to GSM-R could support more permissible configurations than are possible today, but care must be taken to ensure that the number of supported configurations is no greater than is truly necessary, sustainable, and regularly reviewed.....	64
Recommendation 4.	As new bearers are introduced, continued interoperability with GSM-R as deployed must be maintained.....	64
Recommendation 5.	ERA and the European rail sector should consider carefully European certification requirements for operational rail communications. A more granular and flexible certification of operational rail communications equipment would appear to be in order. There should be as few national specificities in the systems as possible (ideally none at all) with the goals of achieving a single certificate in Europe and thereby optimising costs.....	64
Recommendation 6.	The rail sector would be well advised to ensure that rail communications experts participate in 3GPP SA6 standards activities in order to ensure that these potentially crucial standards fully and appropriately address rail communications needs.....	65

- Recommendation 7. Planning should begin incorporating 3GPP LTE-based standardised solutions into a successor to GSM-R. This should be done, as much as possible, in a manner that is independent of specific LTE releases. 66
- Recommendation 8. ERA should consider initiating a study on the use of 3GPP LTE in the existing 4 MHz GSM-R uplink and downlink bands, and possible coexistence with GSM-R in the band. The possible role and relevance (if any) of the E-GSM-R extension bands (873-876 MHz (Uplink) and 918-921 MHz (Downlink)) should also be reviewed at that time. . 66
- Recommendation 9. ERA and the European rail sector should monitor the evolution of radio technologies, such as 5G mobile services, and should consider incorporating support into a successor to GSM-R once the standards are sufficiently mature..... 67
- Recommendation 10. The ERA, the European Space Agency (ESA), and the European rail sector should continue to study the degree to which the use of satellite is feasible and practical for operational rail communications. Current GEO (and possibly LEO) satellites might possibly be acceptable for lines in remote areas with suitable traffic characteristics. Future MEO satellites are likely to have still greater applicability..... 67
- Recommendation 11. ERA and the European rail sector should consider whether the inclusion of Wi-Fi (and/or some other low bandwidth optimised radio bearer) into standards for a successor to GSM-R is warranted. The prime motivations to do so would be to increase capacity in train stations and shunting yards, and also to reduce the cost of communication infrastructures. Coexistence with consumer Wi-Fi would need to be assessed, as well as the planned migration schedule to successors to today's GSM-R. 68

7. Glossary

Abbreviation	Full term
3G/4G/5G	Third/fourth/fifth generation (of mobile telecoms technology)
3GPP	Third Generation Partnership Project
ADL	Asymmetric Downlink
ASA	Authorised Spectrum Access
ASCI	Advanced Speech Call Items
ATO	Automatic Train Operation
ATP	Automatic Train Protection
CAGR	Compound annual growth rate
CBTC	Communications-Based Train Control
CCS-TSI	Control-Command and Signalling Technical Specification for Interoperability
CDMA	Code division multiple access
CEPT	European Conference of Postal and Telecommunications
CSFB	Circuit-switched fall back
EC	European Commission
ECC	European Communications Committee (of CEPT)
ECC/DEC/(02)05	CEPT Report on 169.4-169.8125MHz
EDGE	Enhanced Data Rates for GSM Evolution
EDOR	European Train Control System Data Only Radio
EIRENE	European Integrated Railway Radio Enhanced Network
EPC	Evolved Packet Core
ERA	European Railway Agency
ERTMS	European Rail Traffic Management System
ESA	European Space Agency
ETCS	European train control system
ETSI	European Telecommunications Standards Institute
EU	European Union
EUTC	European Utilities Telecom Council
FDD	Frequency division duplex
FRMCS	Future Railway Mobile Communication Systems
GBNR	Ground Based Network (Resilient)
GCSE-LTE	Group Call System Enabler – LTE
GDP	Gross domestic product
GEO	Geostationary Orbit
GIS	Geographic information system
GPRS	General Pac
GPS	Global Positioning System
GSM	Global System for Mobile Communications
GSM-R	Global System for Mobile Communications, adapted for Railway
HetNets	Heterogeneous Networks
HSPA	High Speed Packet Access
HS Rail	High Speed Rail
IM	Infrastructure manager
IMT	International Mobile Telecommunications
IP	Internet Protocol
IPR	Intellectual property rights
ISI	Inter System Interface
ITU	International Telecommunications Union
ITU-R	International Telecommunications Union Radiocommunication Sector
LEO	Low Earth Orbit communication satellites
LSA	Licensed Shared Access
LTE	Long Term Evolution
M2M	Machine to machine
MCPTTtoLTE	Mission Critical PTT over LTE

MEO	Medium Earth Orbit satellite
METIS	Mobile and wireless communications Enablers for the 2020 Information Society
MNO	Mobile network operator
MORANE	Mobile Radio For Railways Networks In Europe
MTBF	Mean time between failure
MVNO	Mobile virtual network operator
NextG	Next Generation
OFDMA	Orthogonal frequency-division multiple access
OTT	Over-the-top
PA	Public address
PAS	Publicly Available Specification
PLC	Power-line communications
PMR	Private mobile radio
PPDR	Public protection and disaster relief
PPP	Public-private partnership
PTT	Push to talk
RAN	Radio access network
REC	Railway Emergency Call
RF	Radio frequency
RTPI	Real-time passenger information
RU	Railway undertaking (same as TOC)
SAT	System acceptance test
SDL	Supplementary Downlink
SDR	Software-defined radio
SIM (card)	Subscriber identity module
SLA	Service level agreement
SMS	Short message service
TC	Technical Committee (of ETSI)
TCCA	TETRA + Critical Communications Association
TCCE	TETRA and Critical Communications Evolution
TDD	Time division duplex
TEDS	TETRA Enhanced Data Service
TEN-T	Trans-European Transport Networks
TETRA	Terrestrial Trunked Radio
TETRAPOL	An alternative digital radio technology for public safety
TOC	Train operating company
UHF-FM	Ultra High Frequency – Frequency Modulation
UIC	International Union of Railways
UMTS	Universal Mobile Telephone Service (a 3G service)
VBS	Voice Broadcast Service
VGCS	Voice Group Call Service
VHF	Very high frequency
VoIP	Voice over Internet Protocol
W-CDMA	Wideband code division multiple access (a 3G technology)
Wifi	Wireless fidelity
WRC	World Radio Conference

Understanding the Digital World



Evolution of GSM-R

ERA/2014/04/ERTMS/OP

Final report: annexes

April 2015

**To the attention of European Railway Agency
ERTMS**

The opinions expressed in this study are those of the authors and do not necessarily reflect the views of the European Railway Agency (ERA).

40037

Prime contractor: IDATE

Subcontractor: WIK

••• IDATE Project Manager

Frédéric PUJOL

+33 (0)4 67 14 44 50

f.pujol@idate.org

••• WIK Consult

Scott MARCUS

www.idate.org



About IDATE and DigiWorld Institute



Founded in 1977, IDATE has gained a reputation as a leader in tracking telecom, Internet and media markets, thanks to the skills of its teams of specialized analysts. Now, with the support of more than 40 member companies – which include many of the digital economy’s most influential players – the newly rebranded DigiWorld Institute has entered into a new stage of its development, structured around three main areas of activity:

- › **IDATE Research**, an offer of market intelligence publications
 - › **IDATE Consulting**, time-tested analysis
 - › **DigiWorld Institute**, a think tank on the digital economy.
-

Contents

1. Annex 1 - Methodological approach	7
1.1. Project organisation and methodology	7
1.1.1. Organisation of the project	7
1.1.2. General methodology	8
1.1.3. The use of Impact Assessment to frame the problem	10
1.1.4. In evaluating prospective Options and Sub-Options, what criteria should be used?	10
1.2. Adjustments to the methodology following the first workshop	11
1.2.1. Developments to date.....	11
1.2.2. A complex analysis.....	11
1.2.3. European rail decisions	12
2. Annex 2: Results of the workshops	13
2.1. Results of the first workshop	13
General comments on the methodology and approach in general	13
Discussion on the assessment criteria.....	15
Inputs to be sent to IDATE and WIK.....	16
2.2. Results of the second workshop	16
Discussion of the propositions	17
Presentation made by ECO	25
IDATE and WIK Consult conclusions from the workshop	27
2.3. Results of the third workshop	28
Introduction.....	28
Wrap-up.....	28
Comments on the presentation of the interim report.....	29
Comments on the key findings session	31
Future steps.....	34
3. Annex 3 – General Background.....	35
3.1. How railways see the evolution of GSM-R.....	35
3.1.1. GSM-R and the need for a successor	35
3.1.2. Future railways communications functional requirements	36
4. Annex 4: Background information on railway lines & ERTMS implementation.....	41
GSM-R deployments	41
ETCS	42
T.E.N lines	43
Conventional rail vs high speed line	44
Track gauge.....	45
Long distance and regional tracks.....	45

Motor Units	45
5. Annex 5 - Factors that influence the impact of each Option	47
5.1. Spectrum aspects.....	47
5.2. Using MNO technology without rail-specific adaptations	55
5.2.1. Implications of supporting MNO networks with minimal modification.....	55
5.2.2. LTE & LTE Advanced	55
5.2.3. 5G already on the radar - Does European rail need 5G data rates?	57
5.2.4. Possible use of hardened commercial networks.....	59
5.2.5. Hybrid models.....	59
5.3. Integration with PPDR	60
5.3.1. GSM-R and critical communications in other sectors	61
5.3.2. More stringent requirements for mission-critical services	63
5.3.3. PPDR over 2/3G	63
5.3.4. PPDR over LTE	64
5.3.5. Expected capabilities: PPDR over LTE-Advanced	65
5.3.6. International benchmark – PPDR networks.....	69
5.3.7. Broadband PPDR implementation timeline	74
5.3.8. Access to broadband capabilities for PPDR players.....	75
5.3.9. PPDR networks and railways specific needs.....	79
5.4. Support for GSM-R specific features	80
5.4.1. ETCS.....	81
5.4.2. Voice support on LTE	82
5.4.3. EIRENE / MORANE	83
5.5. Cost of existing networks	84
5.5.1. GSM-R	84
5.5.2. TETRA/TETRAPOL.....	84
5.5.3. LTE	85
5.5.4. LTE Rugged	86
5.5.5. Variation in cost with frequencies	86
6. Annex 6 - Literature review	88
6.1.1. Survey on operational communications (study for the evolution of the railway communications system)	88
6.1.2. Is Commercial Cellular Suitable for Mission Critical Broadband?	90
6.1.3. ExPost analysis– operational requirements of railway radio communications systems	97
7. Annex 7 - The scenarios interact with these evaluation Criteria.....	98

Tables

Table 1 :	Synthesis of the poll during the second workshop	24
Table 3:	Number of km of lines covered by GSM-R.....	41
Table 4:	Track km with ETCS in service, as of mid-2013	42
Table 5:	Quantitative comparison of TEN and off-TEN by length (km) of line, as forecasted in 2020.....	44
Table 6:	Fleet of rolling stocks in European countries excluding passengers vehicles, as of 2005/45	
Table 7:	Advantages and risks for LSA.....	53
Table 8:	New technologies and associated benefits in LTE-Advanced.....	56
Table 9:	LTE-Advanced deployment and features.....	57
Table 10:	WiFi generations.....	60
Table 11:	Existing and future radio technologies for railways and other sectors	62
Table 12:	LTE bands	64
Table 13:	LTE-Advanced deployment and features.....	66
Table 14:	3GPP LTE-Advanced freeze dates.....	66
Table 15:	Ownership models – PPDR networks	69
Table 16:	Timeline for broadband PPDR solutions	74
Table 17:	Strategies overview	78
Table 18:	Review of GSM-R features and their possible operation on TETRA and LTE networks .	80
Table 19:	Indicative cost elements for GSM-R networks	84
Table 20:	Indicative cost elements for TETRA/TETRAPOL networks.....	85
Table 21:	Presentation of selected TETRA networks in Europe	85
Table 22:	Indicative cost elements for a commercial LTE networks	86
Table 23:	Indicative cost elements for a ruggedized LTE networks	86
Table 24:	Example of factors and requirements for the assessment	100

Figures

Figure 1:	Proposed work structure.....	8
Figure 2:	Two interrelated decisions to be taken.....	12
Figure 3 :	BB PPDR - 3GPP and CEPT timetables.....	26
Figure 4:	Migration to IP.....	38
Figure 5 :	ETCS data - architecture view	39
Figure 6:	Share of TEN lines in 2020	43
Figure 7:	Share of km of high speed lines and conventional rail in Europe as forecasted in 2020	44
Figure 8:	Share of each type of rolling stock in the European fleet (2005).....	46
Figure 9:	Bodies involved in the PPDR spectrum harmonisation process	47
Figure 10:	CEPT groups dealing with broadband PPDR	48
Figure 11:	Frequency bands targeted by Agurre for high speed data professional radio networks .	49
Figure 12:	Potential channelling arrangements in the 700 MHz within CEPT	50
Figure 13:	Spectrum options.....	51
Figure 14:	The multi-band approach by ACMA.....	52
Figure 15:	The multi-band approach by ACMA: example applications.....	52
Figure 16:	The LSA concept	53
Figure 17:	ASA Spectrum sharing options	54
Figure 18:	Possible timeline for 5G development.....	58

Figure 19:	5G objective for the 5G Forum.....	59
Figure 20:	Cost advantage of WiFi deployment in small cell environment	60
Figure 21:	Coverage and data rates of wireless network technologies	64
Figure 22:	Proximity services examples.....	67
Figure 23:	Group calling.....	68
Figure 24:	Role of Astrid role as an integrator	70
Figure 25:	Virve users breakdown by sectors	71
Figure 26:	Potential evolution of the PPDR networks	71
Figure 27:	HubOne test infrastructure.....	72
Figure 28:	Priority for critical usage.....	73
Figure 29:	Possible migration path towards fully-integrated LTE-based BB data/voice networks....	74
Figure 30:	Strategies for public safety users moving to broadband services	75
Figure 31:	Transfer delay of ETCS messages delivered over LTE during a simulated test performed based on a railway line between Snoghøj and Odense	82
Figure 32:	List of system services that are required by EIRENE FRS	83
Figure 33:	Relation between base station site numbers and operational frequency	87
Figure 34 :	Options in the Analysys Mason report	88
Figure 35 :	Scenarios in the Analysys Mason report.....	89
Figure 36 :	Options and scenarios in the Analysys Mason report	90
Figure 37:	Comparing the options in dedicated and commercial based networks	93

1. Annex 1 - Methodological approach

This section outlines the key principles of our methodological approach, as presented in our tender, which remains the basis for this draft Inception Report.

- We first present a recapitulation of the objectives and scope of the assignment, and the tailored approach we have developed to ensure that the objectives are met while managing the scope in line with the budget and timing of this assignment.
- Second, we present the detailed methodology that we will use task by task, fine-tuned based on the activities carried out during the Inception Phase. Each task and sub-task is led by the relevant team of experts engaged in this assignment.

1.1. Project organisation and methodology

Section 1.1.1 describes the organisation of the project, while Section 1.1.2 describes our overall methodology. Section 1.1.3 expands on the discussion of our use of Impact Assessment methodology as a means of analysing costs, benefits, and trade-offs, while Section 1.1.4 describes the evaluation criteria that we propose to use in assessing various Options and Sub-Options.

1.1.1. Organisation of the project

The Terms of Reference say that the study should be conducted in three steps, but they identify a fourth preparatory step as well, involving the kick-off meeting and the Inception Report. We have generally followed this structure.

In the interest of clarity, we have also identified a distinct over-arching activity: **building the evidence base**. There is one evidence base. It is not tied exclusively to any of three steps.

This activity begins immediately after the kick-off meeting (if not sooner), and proceeds throughout the project, until the end of the final workshop. Indeed, our meetings with ERA, and our interactions with stakeholders in the course of the workshops, feed into this process.

We followed the work structure proposed by the ERA in the tender specifications.

1. The preparatory work included the Kick-off meeting and the Inception Report.
2. The first step of the study included the first workshop and enabled validation of the methodology.
3. The second step will be dedicated to the selection of the feasible options.
4. The third step will be focused on the analysis of combined options.

As planned in the Terms of Reference, we are organising three workshops, two of which have already been held ([see Chapter 9](#)~~see Chapter 9~~):

1. Workshop with stakeholders to discuss the methodology
2. Workshop with stakeholders to select the most feasible solutions
3. Workshop with stakeholders to present the draft final report and validate the conclusions of the second workshop

1.1.2. General methodology

As previously noted, achieving consensus on methodology is one of the desired outcomes of the study, and we propose to approach the task with the appropriate flexibility.

Nonetheless, we feel that it is important for our team to be able to offer a workable concept at the outset, in order to be able to keep the discussion focussed and time-bounded. This section of the proposal provides our initial concept of how to achieve the objectives of the project. What we present here can represent a starting point for discussion.

In order to assess in a structured way the various (non-mutually exclusive) Options available going forward, we propose to draw inspiration and concrete methodological tools from the approach to Impact Assessment that is used by the European Institutions, as documented in the European Commission impact assessment guidelines published in 2009¹.

Impact Assessment provides a means of making qualitative and, where feasible, quantitative comparisons of the costs and benefits of various policy Options that could be pursued.

Conference calls may be organized with the ERA in order to discuss the methodology (two or three brainstorm sessions).

We are following the work structure shown in the figure below:

Figure 1: Proposed work structure

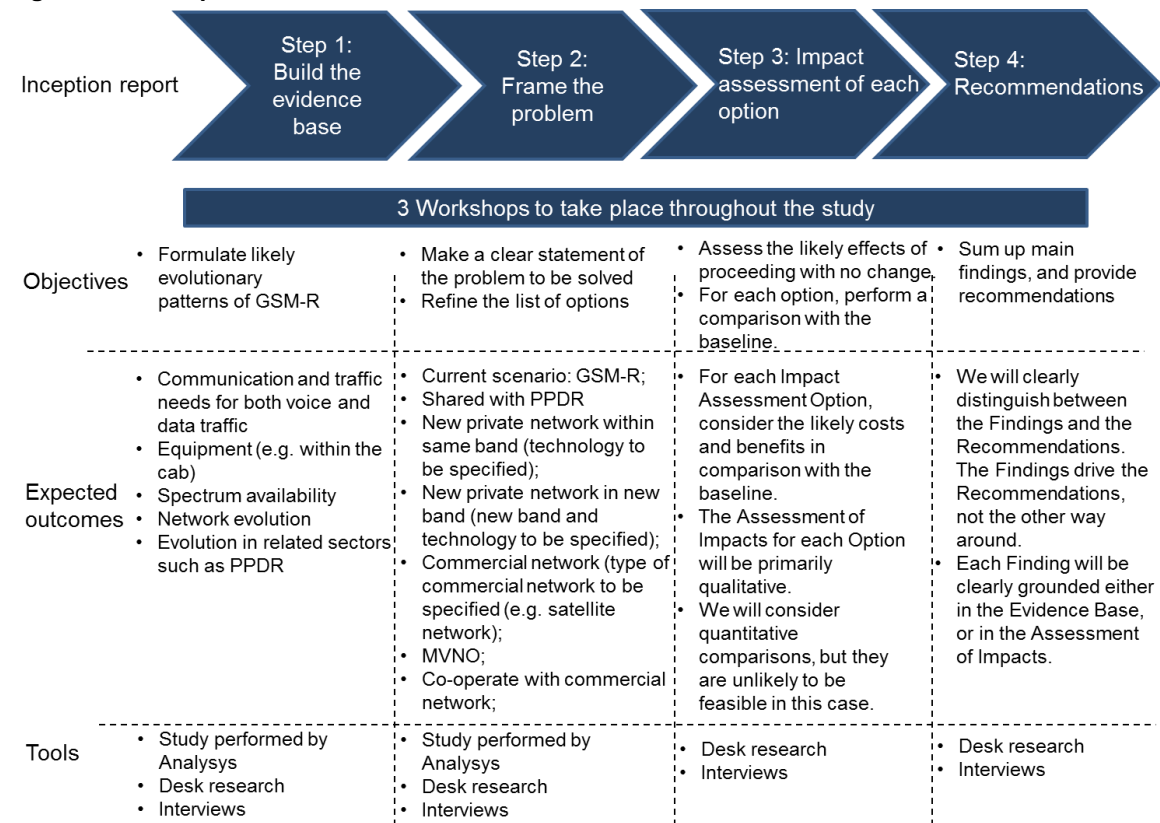

S1: Build the evidence base

- We began with a thorough review and assessment of the previous study, which provides among other things
 - Application requirements (current and expected future)
 - Network architecture models

¹ European Commission (2009), Impact Assessment Guidelines, 15 January 2009, available at: http://ec.europa.eu/smart-regulation/impact/commission_guidelines/docs/iag_2009_en.pdf. For a list of related documents, and pointers to possible ongoing revisions through the REFIT process, see http://ec.europa.eu/smart-regulation/impact/commission_guidelines/commission_guidelines_en.htm.

- A list of scenarios
- Quantitative/market information
- Strengths, Weaknesses, Opportunities, Threats (SWOT) analysis of different options
- An almost-complete study of mission critical communications conducted by SCF on behalf of the European Commission represents a new and important input to our study.
- Other desk research
 - Identify data sources
 - Benchmark with other sectors: aviation, maritime, traffic, blue light services
 - Review and summarise the data for use within the team
- Interview relevant stakeholders (at least 15 interviews)
- Collect and reflect ERA and stakeholder input throughout the project
 - Telephone conferences and discussions with ERA/ERTMS
 - Feedback from formal Meetings with the ERA
 - Input and feedback from the three Workshops
- Formulate likely evolutionary patterns based on these inputs
 - Communication and traffic needs for both voice and data traffic
 - Migration scenarios
 - Equipment (e.g. within the cab)
 - Spectrum availability
 - Network evolution
 - Evolution in related sectors such as PPDR

S2: Frame the problem

- Make a clear statement of the Problem to be solved
- Clearly identify and delineate the general, specific, and operational Objectives. Key indicators are functionality, QoS and availability, also covering capacity, technical feasibility and costs
- Identify promising Options (with a capital “O”) and sub-Options for purposes of Impact Assessment. As explained earlier, we are developing our own Options rather than taking the results of the previous study as a given.

S3: Assess impacts of each Option and sub-Option

- Assess the likely effects of proceeding with no change (business as usual). This provides a baseline for comparison.
- For each Impact Assessment Option, consider the likely costs and benefits in comparison with the baseline.
- The comparison typically begins by considering effectiveness and efficiency in achieving the Objectives. Beyond that, we will as required consider punctuality, safety, economic efficiency at IM-side, economic efficiency at RU-side, and economic efficiency of other actors.
- The Assessment of Impacts for each Option will be primarily qualitative. We will consider quantitative comparisons, but they are unlikely to be feasible in this case.

S4: Formulate findings and recommendations

- We will clearly distinguish between the Findings and the Recommendations. The Findings drive the Recommendations, not the other way around.
- Each Finding will be clearly grounded either in the Evidence Base, or in the Assessment of Impacts.

- It is conceivable that a clearly preferred Option will emerge as a Recommendation. More often, the Impact Assessment serves to clarify the merits of each Option for decision makers who must then make the choice.
- Feasibility of the Options (for example, political practicality) is reflected at this phase rather than earlier, so as not to prematurely exclude otherwise workable solutions.

1.1.3. The use of Impact Assessment to frame the problem

Among the European institutions, Impact Assessment provides a useful means of analysing costs and benefits of prospective policy interventions.

Properly applied, Impact Assessment serves not only to assess impacts, but also to assist in the proper formulation of policies.

In this case, use of standardised Impact Methodology also assists ERA in communicating results to the European Commission, and assists the Commission (if necessary) in communicating results to the European Parliament and the Council.

Among the key steps of the Impact Assessment procedure are:

- Clear definition of the Problem to be solved
- Identification of the Objectives
 - General Objectives
 - Specific Objectives
 - Operational Objectives (this last being partly driven by the nature of the Options under analysis)
- Identification of Options (and possibly Sub-Options) that could achieve some or all of the Objectives
- Assessment of the likely Impacts (positive and negative) of each of the most promising Options and Sub-Options

1.1.4. In evaluating prospective Options and Sub-Options, what criteria should be used?

Standard Impact Assessment practice begins with three broad categories of evaluation criteria, differentiating and adding more based on the nature of the problem to be solved.

Effectiveness

Effectiveness: To what extent is the Option likely to achieve one or more of the Objectives? To what extent is it likely to solve (or at least mitigate) the Problem?

Effectiveness must consider both normal operation and operation under stress (e.g. at times of bad weather, natural or man-made disasters ...). Compliancy to the requirements for functionality, availability, QoS and capacity are mandatory.

- Among the elements of Effectiveness:
 - Coverage (availability of radio access)
 - Reliability of the chosen technological solution
 - Robustness (in the face of disruptions and disasters)

Compliancy to requirements is a precondition for punctuality and safety (as far as not covered by signaling).

Efficiency

What is the expected cost of implementing the option? Cost in this sense is not only direct economic cost, but should also consider social costs and externalities. Do alternative Options achieve the Objectives at lesser cost?

- The cost of deployment and operation. This would include both CAPEX and OPEX. Many costs are directly borne by the infrastructure managers (IMs), but are effectively passed

through to the railway undertakings (RUs, i.e. train operating companies) through track access charges.

- Network costs
- Cab equipment costs
- Training costs
- Transition costs from the old environment to the new (together with possible parallel operation of both)
- Economic costs and benefits (efficiency) of other actors

Coherence

Is the Option consistent (or in conflict with) other societal goals and programmes at European level?

- Degree to which spectrum requirements for rail (especially sub-1 GHz) might potentially conflict with use of the same spectrum for other DAE objectives such as mobile broadband, or conceivably with use by PPDR?

1.2. Adjustments to the methodology following the first workshop

In the First Workshop, we presented the general framework used in a previous study by Analysys Mason, as called for by the ERA's Terms of Reference. Based on stakeholder response, we felt that a different approach was needed; consequently, we crafted a substantially different approach, which is reflected throughout this Intermediate Report.

This section explains what changed, and why.

1.2.1. Developments to date

The initial Terms of Reference for this project call on us to focus on the Options defined in the previous Analysys Mason (2014) study.

We (ERA and the study team) conducted a small workshop in Lille on 15 October to review the overall methodology, Options to be considered, relevant scenarios for implementation, and criteria to be used for evaluation.

- We presented a set of “options” and “scenarios” based on the previous Analysys Mason study, which we had assumed to be well accepted by this community.
- Many of the stakeholders expressed considerable doubts about the Options and scenarios.
- We promised to re-examine the Options, scenarios, and linkages among them.

Meanwhile, a draft of a new and important study of “mission critical” communications (PPDR, rail, and energy) by SCF on behalf of the European Commission was published in October, and also presented 15 October.

- It reflects a substantially different set of Options.
- They do not seem to be less problematic than the Analysys Mason options.

Having looked more closely at the matter, we consider the stakeholder concerns over the Options and scenarios to be well founded.

1.2.2. A complex analysis

There is a complex interplay between:

- Cross-sectoral decisions made at European level
- Rail-specific decisions taken at European level

- Member State decisions

Figure 2: Two interrelated decisions to be taken

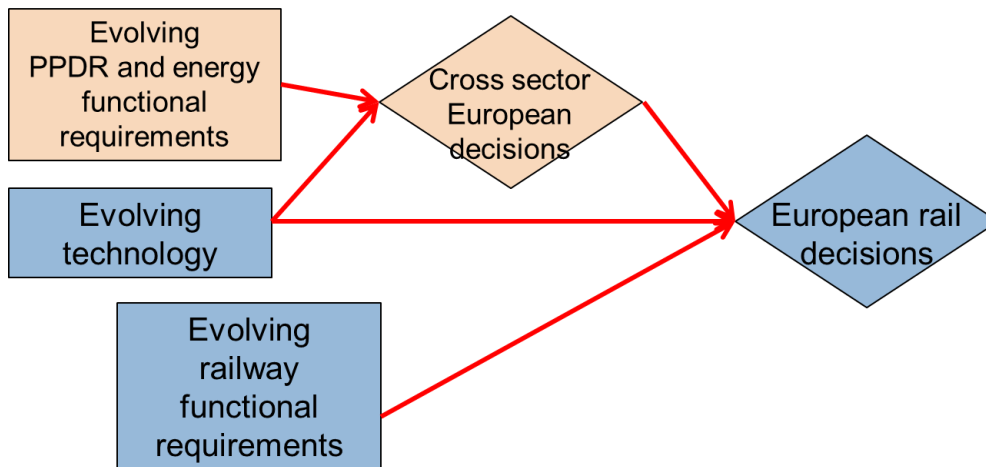

For purposes of our study, we will distinguish between two interrelated sets of decisions: (1) A cross-sectoral decision at European level as to how to handle PPDR, energy, and rail communications overall, and (2) a rail-specific decision. Rail influences the first of these decisions, but does not control it; at the same time, the first decision bounds the frontier of possibilities for the second.

1.2.3. European rail decisions

Again, our study is concerned with rail decisions at European level. Instruments available to ERA (and UIC) are TSI, EIRENE and ERTMS/ETCS Specifications (Annex A).

The most crucial decision instrument at European level is the TSI.

A key set of decisions at European level in regard to functionality currently delivered by means of GSM-R is:

- Should operation over commercial mobile networks become a supported mode?
- Should operation over future PPDR broadband networks become a supported mode?
- Should operation over a dedicated network for railways be recommended?
- Should operation over hybrid networks become a supported mode?

The answers to these two questions have strong implications for the *technologies* and *spectrum bands* that must be supportable.

- Rail communications are a relatively small segment compared to the overall mobile market².
- Rail communications are a relatively small segment compared to the PPDR segment.³
- Rail communications have only limited ability to drive the evolution of either network

Integration with PPDR also influences the likely migration scenario and time frame (since PPDR broadband requirements are likely to manifest long before GSM-R is obsolescent).

In the event that operation over commercial networks or PPDR broadband networks is *permitted anywhere*, then the TSI needs to reflect a new supported configuration.

² The overall mobile market in Europe represents more than 700 million mobile subscriptions (source: IDATE) whereas the number of GSM-R terminals is probably under 100,000 (source: Analysys Mason)

³ Evaluation of PPDR in Europe 17 by ECC: between 1,200,000 and 1,700,000 users

2. Annex 2: Results of the workshops

2.1. Results of the first workshop

The first workshop took place on the 15th of October 2014 in Lille. The workshop focussed on methodology and assessment criteria.

General comments on the methodology and approach in general

Need to review linkage of Options vs Scenarios

It was commented that options and scenarios are obviously linked with each other, but also that there might be a need to create some variations of existing options and/or scenarios.

Attendees proposed for instance to create a variation of what Analysys Mason called "Option 2" (new technology, same band): in this case, there could be a variation which would consider "new technology, same band" + use of an additional band (E-GSM-R for instance).

This is an important comment, as the study might end-up recommending a mixture of options as the best solution for the evolution of GSM-R.

IP-based bearer-independence is important

It was expressed by many participants of the workshop that the future radio communications system should be based on a radio bearer independent of the application layer: the IP layer should be transparent from the radio access bearer. This will enable a smooth transition and will provide a future-proof solution.

Many requirements are application specific

There were some comments that many requirements are application specific: some applications (ETCS level 2 for instance) might lead to certain requirements, while other applications (REC (Railway Emergency Call- for instance) might lead to other requirements.

Regarding this issue, it was proposed to add a column "application" in the table showing some examples of the factors and requirements for the assessment.

It remains unclear however if doing so is sufficient or if there is a need to duplicate all tables, by application. The way of integrating this request in the methodology of the assessment needs to be further analysed by IDATE and WIK.

How to deal with risk/uncertainty?

Some comments were made on the necessity to consider how the regulatory context might evolve over time. As a matter of fact, there is an uncertainty related to the possible evolution of laws for instance, or evolving regulation.

To take this into account, and as proposed by ERA, we will explain in the assessment what laws/facts/regulation need to be changed in order to meet the requirements of a given solution.

There is also a strong need to assess the risks associated with each technology. IDATE and WIK noted that the criteria assessing the independency of the bearer partly answers to this issue.

Ownership, control ...

We need to assess further how to integrate the issue of network ownership in the study. As a matter of fact, owning the network allows the IM to control the functionality, and also control the future evolution of the network.

The following questions are to be addressed:

- Is a dedicated private network needed for the railways community?
- The answer will directly impact the analysis, beyond reviewing the possible options
- If the network is not owned, how to influence the wished evolutions of the network following new requirements (how to control functionalities available on the network)?

This has to be taken into account in the assessment criteria.

What role for competition?

It was asked to consider more extensively the competition factor in the assessment criteria.

Competition englobes several points:

- Competition between possible technological solutions: this has a direct impact over the choice of options/scenarios.
- Competition between players. On the terminal side for instance, assessing the market size allows gauging the issues related to spare parts and the economies of scale which are likely to be achieved, and the consequent gain on terminal prices.
- Competition with other transportation means: DB Netz mentioned the passenger track fee more expensive than a bus ticket, with a resulting loss of railway passengers.

Avoid gold-plating

It was indicated during the workshop that the solution should be chosen depending on an optimized trade-off between costs and QoS. Under “avoid gold-plating”, we mean that a given solution offering a 99.5% availability rate might be more relevant in the assessment if it is, for instance, two times cheaper to deploy than another solution offering a 99.8% availability rate.

Migration issues

It was mentioned that the migration process should be a step-by-step one and that practical implementation should be kept in mind.

SBB also pointed out that network sharing between commercial mobile networks is not allowed in Switzerland today. If sharing is also forbidden between PRR networks, this is a significant hurdle for the associated migration option.

Growing interference to GSM-R (cost!)

Interferences between GSM-R and GSM have been found in many locations. In some cases they have been resolved on a case by case basis, either by the public operator or by the GSM-R operator. There are still many locations (over 700) in Europe where interferences are present. The competences over spectrum are delegated to each Member State, and the radio licenses (establishing the rights of use of a radio band) for public operators and for GSM-R operators do not consider restrictions in general.

It was stated that there are increasing interferences to GSM-R since 2 years. It is expected the situation will get worse over the coming years. The European Railway Agency is currently working in close cooperation with DG MOVE, DG CONNECT, ECC/CEPT and the sector to help on the understanding and to provide tools to prevent or resolve the cases where interferences appear.

As ECC has issued Report 96 and 162 to study the compatibility between broadband technologies used in the 900 MHz and 1800 MHz radio bands and GSM-R, IDATE and WIK will have to check this further in the analysis to be performed.

Interdependencies among criteria

It was highlighted that the criteria are not exclusive: for example, coverage directly impacts costs. The same way, reliability has a direct impact on costs as well.

There needs to be found a way to take into account this interdependency in the criteria assessment.

To what degree are national differences accommodated?

Several attendees required to consider national specificities in the study, as the current level deployment of GSM-R is not the same country by country. Also, we see in some countries a move to switch from GSM-R to TETRA networks (in Finland for instance). Within this context, a given scenario might be relevant for a specific country and not for another one.

It was recommended to review what decisions were taken in other continents (Australia for instance) as a useful input for the analysis to be performed.

Many useful issues were raised, many aspects need more detailed thought

A lot of comments were made on the interoperability issue. This will be further analysed in the assessment criteria study.

ERA also suggested considering satellite as a possible solution in the study (*an interview with the European space agency is to be performed during the study*).

Discussion on the assessment criteria

After discussion with the stakeholders during the workshop, we noted the following criteria to be added to our previous list:

- **Security:** Security embraces both jamming of radio networks and hacking of IP-based networks. Originally the terms jamming and interferences were used interchangeably but nowadays most radio users use the term "jamming" to describe the deliberate use of radio noise or signals in an attempt to disrupt communications (or prevent listening to broadcasts).

Hack is "Break into computer systems or software" and is increasingly being performed for intrusion in IP networks.

Several attendees indicated there needs to be found a criteria dealing with the resistance to jamming, and even hacking though the increasing deployment of IP-based solutions. The fact that railway networks are not in a closed circuit mode and are connected to the Open Internet increases risks of intrusion.

- **Migration ability, costs of transition:** As the future solution will require both backward compatibility with existing solutions and a step-by-step migration seems to be preferable, there is a need to create a criteria taking this "migration ability" into consideration.

It remains to be assessed if the costs of transition are integrated in this criterion or need to lead to the creation of a new and specific criterion.

- **Time sequencing / lifetime:** There needs to assess the time development/deployment of the new system when assessing the different solutions likely to be chosen and expected lifetime of these solutions. This criteria becomes particularly relevant when assessing

new technologies in new frequency bands for instance (need to assess likely spectrum allocation timelines).

- **Certification:** terminal certification is critical so it needs to be evaluated through the creation of a specific criterion. On this point, IDATE and WIK indicated there will be a need for inputs from ERA and the railways community (action specified in part 4 of this report).
- **Staff competency requirements:** Several attendees indicated it becomes difficult hiring experienced people in radio/IP networks and this has a direct impact of overall costs (costs of training and salary costs). If a given solution requires a strong need to hire and train new staff, it has to be taken into account in the criteria assessment.

However, it was also indicated that this issue can be undermined by alternative solutions such as network sharing/outsourcing.

- **Ease of use:** It was reported there is a strong requirement to make the system as simple as possible. The term “plug and play” was even mentioned.
- **Traffic prioritization:** the selected system needs to be able to control traffic overload and manage communication priorities. A specific criteria on this topic needs to be created.
- **Verifying operator compliance with obligations:** how to measure that operators do comply with their obligations (QoS) is a strong requirement from the railways community. The services needed by the GSM-R community have to be traceable, contractable. If not, the services fail in compliancy requirements.

Inputs to be sent to IDATE and WIK

It was agreed that as far as possible, the following inputs would be sent to IDATE and WIK for consideration in the current ERA study:

- Comments on Analysys Mason report (options/scenarios) & SCF report entitled “Is Commercial Cellular Suitable for Mission Critical Broadband?”
- A list of broadband applications to be useful or critical for railways in the future?
- Costs of certification to date
- Costs of training
- Costs of standardisation
- Market characteristics and size (in order to compare with other markets, as requested by ERA)
- Interference to GSM-R (Valenciennes)

2.2. Results of the second workshop

The second workshop on evolution of railway radio communication system took place on 26th November 2014 in Valenciennes. This workshop was intended to get information from the attendees about several subjects which are relevant for the study. The methodology used was to present – prepared - statements and to discuss these statements. Before and after the discussion of each statement a poll was held to get an impression of the benefit of the information from the discussion.

Discussion of the propositions

Question 1: The only way to have full control over compliance with railway requirements is to have a dedicated network for railway mission critical services.

1st poll

Answers Yes to this question: 20

Answers No to this question: 24

General comments made by the audience:

- A question was raised regarding the need to take into consideration other aspects of the railways, such as maintenance which includes a lot of sensors. These sensors have a large impact on the capacity requirements of the communications system.
- A comment was made to take into account future needs, and take into account innovative technologies such as dynamic spectrum allocation, software defined radios, etc...
- A comment was made on the fact that an answer to this question might strongly be linked with the nature of the line considered (regional line, high speed line, etc...).
- The difficulty to manage devices using SDR (Software Defined Radio) or cognitive radios technologies was underlined by some participants.

Question 3: Public operators are very interested to offer railway services and to invest in hardening their network to fulfil the railway requirements (including 99,999% availability requirement)

1st poll

Answers Yes to this question: 2

Answers No to this question: 50

General comments made by the audience:

- a key aspect of this question will be tied with the contract conditions, such as the penalties.
- the availability is strongly linked with the requirements from the IM. If the requirements are not too high, meeting them is feasible. For RFF, public networks are not able to offer such reliability rates at the moment.
- 99,999% is an utopia and cannot be considered as a realistic figure.
- MNOs do not cover the rail tracks currently, as there is no business model for them to do so. IDATE and WIK indicated that PPPs can be a solution to this issue.
- An MNO indicated that they do operate a GSM-R network on a contract basis. This contract includes coverage obligations attached to the services being provided by the operator.
- availability figure as far as applicable on the radio part, is too high, especially when considering spectrum below the 1GHz band. He added that for him, 99.9% would be a realistic figure for a really hardened network (99.999% is seen as completely unrealistic for commercial networks).
- it is complicated to give a unique figure, as the availability rates are decided on a country by country basis, line by line.

2nd poll

Answers Yes to this question: 1

Answers No to this question: 50

Question 11: (From SCF-report) A hardened public network is at least 30% more cost efficient compared to dedicated network (in greenfield situations)

1st poll

Answers Yes to this question: 8

Answers No to this question: 14

General comments made by the audience:

- It was stated that the railways sector is very reluctant to update technologies at the same pace as commercial mobile networks
- A comment was also made that service costs could be higher with such networks
- how is this figure being quantified
- A comment was made that 70% of the costs are greenfield costs. However, a major part of the existing equipment could be reused for the future system (cell sites, backhauling links...).
- Some comments were made on the spectrum aspects: it was indicated that the public operators will have rules to follow to access to spectrum. How can the railways sector empower the national bodies to issue the spectrum needed?
- another issue is tied with the spectrum opportunity costs which are a very political decision made at the country level. "Be aware of spectrum opportunity costs below 1 GHz for MFCN (ROM of 2 Euro/MHz/capita)"
- in all cases, it is difficult to quantify the exact cost savings made by the use of hardened public networks, as there are not any such systems in operation today.

2nd poll

Answers Yes to this question: 6

Answers No to this question: 20

Question 16: Using public network is not realistic because fulfilling the conditions mentioned in the SCF-report are not feasible

1st poll

Answers Yes to this question: 20

Answers No to this question: 7

The conditions mentioned in the SCF report are detailed in annex of this report (see section 4).

General comments made by the audience:

- one scenario could be to use blue light services. PPDR is looking for customers, including customers from the railways sector.
- A comment was made that a lot of assumptions are based on either public or private networks. The future system might be based on both.
- in three years from now, it will be possible to bring 300 Mbps to a train for passenger connectivity and even 1 Gbps in the future. Amtrak in the USA is having such a project with the deployment of one base station every km for the provision of 100 Mbps data rates on the train for passengers. It was commented on the possibility to use the existing equipment along the tracks (mission non critical) for mission critical communications.
IDATE and WIK answered that the Analysys Mason study indicated this scenario but it would probably be difficult to implement.

2nd poll

Answers Yes to this question: 20

Answers No to this question: 6

Question 2: Networks, services, user equipment of PPDR are fully suitable for Railways and able to carry the very limited communication needs of Railways, even in urban areas and during events or casualties. Only some preconditions have to be agreed upon.

1st poll

Answers Yes to this question: 5

Answers No to this question: 15

General comments made by the audience:

- There were several comments on the word “very limited”: these needs will change in the future, especially considering the 2030-2040 timeframe. UIC indicated that they are working jointly with ERA on this matter. A project is going on and the preliminary results should be available in June 2015. Network Rail added ERA should organize a workshop on the future applications needed for railways.
- Finland intends to use TETRA networks for railways communications, but only for voice, not data. There will be a need for a TSI compliant network for ETCS 2.
- at the CEPT level, there are some talks on the 700 MHz band and talks between PPDR and public mobile operators. On the radio link, simulations for Paris show that public mobile operators can ensure 97% availability.
- It was questioned if all the current functionalities will be migrated in the future system. Some say yes, others say no: this would need a better assessment.

2nd poll

Answers Yes to this question: 3

Answers No to this question: 20

Question 4: Satellites cannot offer the required railway functionality due to latency and lack of in-built data integrity

1st poll

Answers Yes to this question: 20

Answers No to this question: 5

General comments made by the audience:

- ESA commented that satellite brings several advantages, the first one being coverage. With satellite, there is no need to install BTS equipment every 5-10 km. ESA is currently performing some projects investigating the use of satellite: use of satellite for ERTMS 3 (tests in Sardinia), SATCOM4Rail project ongoing.
- GEO satellite have a latency of 245 ms but ESA studied a MEO (medium Earth Orbit) satellite system in the C-band and came to the conclusion that such a system would reduce the latency to 70ms.
- ESA is to publish a report on the potential of satellite use for the railways sector (Satcom4Rail).
- UIC added that satellite can be useful to bring connectivity in very remote areas where there are no other communications systems available. Satellite will be good enough for certain railway lines.

2nd poll

Answers Yes to this question: 15

Answers No to this question: 15

Question 5: Introducing IP as overall bearer offers all flexibility, scalability, capacity, availability and performance Railways ever will need. Industry needs to develop IP suitable Voice and ETCS application platforms

1rst poll

Answers Yes to this question: 50

Answers No to this question: 0

General comments made by the audience:

- No comments were made, as everyone agreed on this question

Question 6: A dedicated band adjacent to the 700 MHz commercial band could suffer from interferences

1rst poll

Answers Yes to this question: 20

Answers No to this question: 1

General comments made by the audience:

- It was commented that every commercial band adjacent can suffer interferences, not only the 700MHz band.
- Any hacker can interfere if he wants to.

2nd poll

Answers Yes to this question: 20

Answers No to this question: 0

Question 7: The different line categories and their different requirements (voice, voice + ETCS, rural lines) will lead to different network models

1rst poll

Answers Yes to this question: 35

Answers No to this question: 2

General comments made by the audience:

- In some countries it is already the case today: GSM-R is used 50% of the network, and public roaming for the remaining 50%
- There is a best effort coverage on some lines: this will continue in the future.

Question 19: Co-existence with other networks will require shifting some/all railway GSM-R features towards the application level in GSM-R (radio bearer independence)

1rst poll

Answers Yes to this question: 8

Answers No to this question: -

General comments made by the audience:

- No comments were made

Question 13: Specific spectrum and one single technology for railway use, harmonized all over Europe, is not needed. On-board and handheld equipment (e.g. software defined radios) can support plenty of frequency bands and access technologies (Wifi, Satellite, LTE) and will be available around 2020

1st poll

Answers Yes to this question: 18

Answers No to this question: 11

General comments made by the audience:

- It was commented that even if such radios will be available by 2020, the railways sector will have difficulties to certify such equipment (too expensive).
- Moreover, the certification of devices (software) will be complicated, as there will probably be different network models depending on the lines considered
- It was also commented that the regulatory context needs to evolve in order to allow such possibilities. IDATE answered that there are already some evolutions in the regulation. For instance, LTE-U (unlicensed) could compete with WiFi. There are also some spectrum sharing possibilities too.
- there is currently a tender in the UK for a PPDR service done on a MNO network. However, IDATE indicated this tender remains an exception today.
- the most important is that the on-board system can sustain all frequency bands.

2nd poll

Answers Yes to this question: 12

Answers No to this question: 10

Question 14: Spectrum managing authorities will continue to put pressure in order to free up the GSM-R and GSM-R extension band due to low utilization ratios

1st poll

Answers Yes to this question: 6

Answers No to this question: 14

General comments made by the audience:

- there is no refarming process of the GSM-R band. It is a question of time until the band will be put under pressure
- The E-GSM-R band is used as an ISM band in the USA (used by RFID). There is some pressure in Europe for the re-allocation of this band to unlicensed use.
- There was a comment that the existing 4MHz of spectrum + an extended band could be used for the future system. The railways sector needs to demonstrate usages could be high enough to keep using this band.
- Some comments were made that the lobbying efforts of the railways sector must improve. ECO indicated the presence of the railways industry at the CEPT has improved over the past year. The railways sector should be more informed about the developments of other sectors.

2nd poll

Answers Yes to this question: 5

Answers No to this question: 10

Question 15: A single network for mission critical services would be by far the best spectrum and cost efficient solution

1rst poll

Answers Yes to this question: 3

Answers No to this question: 15

General comments made by the audience:

- Important will be who would own/control the communications network (the entity who owns the network will have full control over it).
- There were doubts about coverages along the railways (PPDR coverage is probably low).
- There were some comments on the costs of this network. It was noted that the fixed part of the network should be shared (by PPDR and utilities). WIK Consult indicated this is a very small part of the total costs.
- UIC indicated they considered this question as a serious scenario

2nd poll

Answers Yes to this question: 8

Answers No to this question: 12

Question 8: Obsolescence: “e.g. Trackside: once LTE is developed for other professional users, the business case of GSM-R will quickly be worse compared to LTE ...”

1rst poll

Answers Yes to this question: 7

Answers No to this question: 7

General comments made by the audience:

- the business will change actually much faster than the obsolescence itself

2nd poll

Answers Yes to this question: 7

Answers No to this question: 7

Question 9: Migration will be very cheap if we use a frequency band equal or lower than the GSM-R frequency band (trackside + vehicles)

1rst poll

Answers Yes to this question: 9

Answers No to this question: 11

General comments made by the audience:

- “very cheap” is not the right work for a €2Bn system. Reusing existing sites should be encouraged.
- envisage the migration costs of the equipment in trains
- radios should be designed so that it is very simple to upgrade them (and to replace them in the locomotive).

2nd poll

Answers Yes to this question: 12

Answers No to this question: 9

Question 10: Railways cannot afford to have a huge amount of experts to design, build, maintain communication facilities. Railways have to define their communication needs in a way that they can benefit from standard services, provided by specialists outside the railways

1st poll

Answers Yes to this question: 6

Answers No to this question: 12

General comments made by the audience:

- it is very expensive to have a dedicated team of experts. It is above all a political choice.
- In some countries they're training technicians to be able to deal either with ETCS or telecom failures in an attempt to reduce costs.

2nd poll

Answers Yes to this question: 8

Answers No to this question: 12

Synthesis of the poll

Table 1 : Synthesis of the poll during the second workshop

Proposition	First poll		Second poll	
	Yes	No	Yes	No
#1: The only way to have full control over compliancy of the railway requirements, is to have a dedicated network for railway mission critical services	20	24		
#2: Networks, services, user equipment of PPDR are fully suitable for Railways and able to carry the very limited communication needs of Railways, even in urban areas and during events or casualties. Only some preconditions have to be agreed upon	5	15	3	20
#3: Public operators are very interested to offer railway services and to invest in hardening their network to fulfill the railway requirements (including 99,999% availability requirement)	2	50	1	50
#4: Satellites cannot offer the required railway functionality due to latency and lack of in-built data integrity	20	5	15	15
#5: Introducing IP as overall bearer offers all flexibility, scalability, capacity, availability and performance Railways ever will need. Industry needs to develop IP suitable Voice and ETCS application platforms	50	0		
#6: A dedicated band adjacent to the 700 MHz commercial band could suffer from interferences	20	1	20	0
#7: The different line categories and their different requirements (voice, voice + ETCS, rural lines) will lead to different network models	35	2		
#8: Obsolescence: "e.g. Trackside: once LTE is developed for other professional users, the business case of GSM-R will quickly be worse compared to LTE ..."	7	7	7	7
#9: Migration will be very cheap if we use a frequency band equal or lower than the GSM-R frequency band (trackside + vehicles)	9	11	12	9
#10: Railways cannot afford to have a huge amount of experts to design, build, maintain communication facilities. Railways have to define their communication needs in a way that they can benefit from standard services, provided by specialists outside the railways	6	12	8	12
#11: From SCF-report: A hardened public network is at least 30% more cost efficient compared to dedicated network (in greenfield situations)	8	14	6	20
#12: Existing GSM-R sites should be sold to public operators in order to get a return on investment				
#13: Specific spectrum and one single technology for railway use, harmonized all over Europe, is not needed. On-board and handheld equipment (e.g. software defined radios) can support plenty of frequency bands and access technologies (Wifi, Satellite, LTE) and will be available around 2020	18	11	12	10
#14: Spectrum managing authorities will continue to put pressure in order to free up the GSM-R and GSM-R extension band due to low utilization ratios	6	14	5	10
#15: A single network for mission critical services would be by far the best spectrum and cost efficient solution	3	15	8	12
#16: Using public network is not realistic because fulfilling the conditions mentioned in the SCF-report are not feasible	20	7	20	6
#17: Railway mission critical applications do not require broadband				
#18: Capacity is not an issue once ETCS over GPRS is developed				
#19: Co-existence with other networks will require shifting some/all railway GSM-R features towards the application level in GSM-R (radio bearer independence)	8	0		
#20: Railways are not special and can be compared with all kind of other professional users of mobile communication. (no specific railway functionalities/dedicated technology required)				

Presentation made by ECO

ECO (European Communications Office) made a presentation entitled “Activities in CEPT ECC/WGFM in relation to the Evolution of the Radio Communication System”.

In this presentation, he made the following comments:

Relation to Draft ECC Report 218

- It is planned to submit the draft ECC Report to the next WGFM meeting in February 2015 for public consultation approval. This ECC Report is complementary to the ECC Report 199 “User requirements and spectrum needs for future European broadband PPDR systems (Wide Area Networks)”.
- The process for this was triggered by ETSI SRDoc TR 102 628. The revised SRDoc also includes a section on synergies and mentions possible synergies between BB-PPDR, future railway communications and possibly other sectors such as ‘smart grids’.
- Both, ETSI TR 102 628 and ECC Report 199 identifying 2x10 MHz as demand for BB-PPDR wide area networks.
- The RSPG Report on Sectorial Needs emphasises that the normal ETSI-ECC collaboration process should be followed to express spectrum needs (means ...SRDoc!). Note that there was also ETSI SRDoc TR 102 627 for E-GSM-R or ETSI TR 103 113 for Urban Rail Systems (latter one in process in WGFM/ SRD/MG).

Draft ECC Report 218

- Draft ECC Report 218 recognises a concept of “flexible harmonisation” to enable an efficient implementation of BB PPDR within CEPT. This includes major elements:
 - common technical standard (i.e LTE and its evolutions)
 - national flexibility to decide on how much spectrum should be designated for PPDR within harmonised tuning range(s), according to national needs
 - national choice of the most suitable implementation model (either dedicated, commercial or hybrid)
 - National and international interoperability
 - Candidate spectrum ranges:
 - 410-430 MHz,
 - 450-470 MHz,
 - 700 MHz (IMT-band 694 – 790 MHz) – several options
- Noting that manufacturers can produce multiple band integrated chipsets, based on common LTE advanced standards including the designated PPDR ranges, a common technology for PPDR user terminals.

Figure 3 : BB PPDR - 3GPP and CEPT timetables

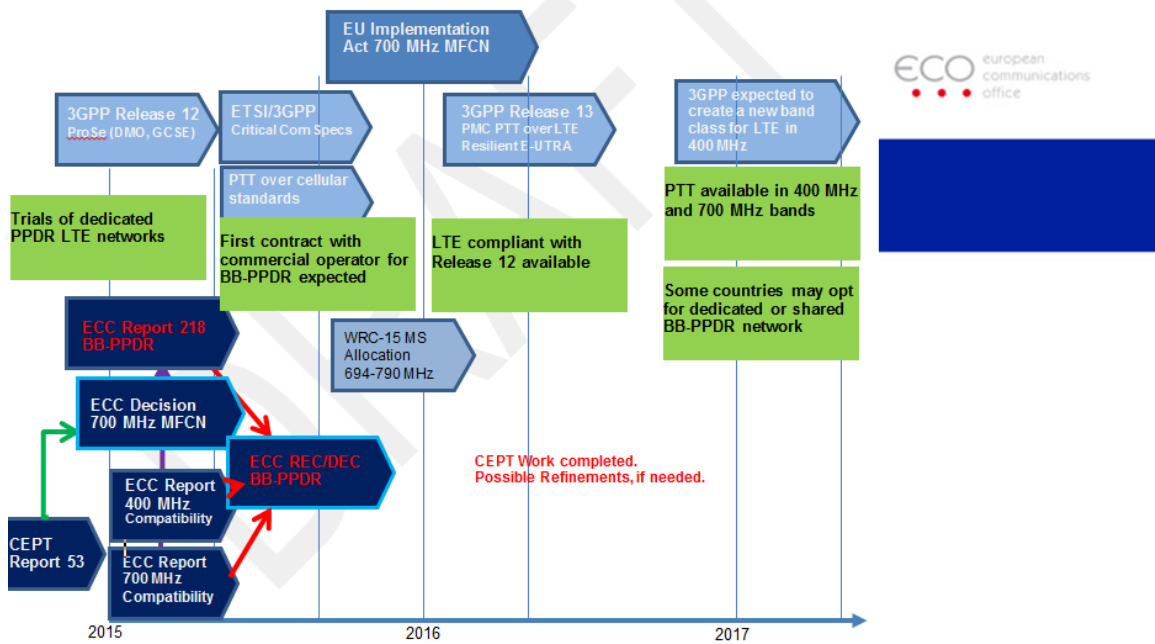

Roadmap – Note: current NB/WB PPDR in place at least until 2025/30

Source: ECO

Synergies, principles, process

- Principle of intelligent sharing (note that railways are not everywhere in a country, so the frequencies could potentially also be used by others, as long as the priorities are clear).
- Normally bands are allocated as technologically neutral but could be made specific for interoperability reasons (see draft ECC Report 218 -> LTE)
- Support from administrations needed (administrations are also ETSI members!)
- Frequencies below 1 GHz are strongly advised when it comes to rail safety related applications and low latency required (beyond GSM-R)
- Be aware of spectrum opportunity costs below 1 GHz for MFCN (ROM of 2 Euro/MHz/capita)
- Include options in SRDoc incl. current GSM-R/E-GSM-R (e.g. for 1.4 MHz LTE studies?)
- The philosophy is that LTE and further evolutions are used by the network and that user equipment (cab radios and handhelds) have implemented multiple bands. The network implementation and precise frequency option is then a national decision. All options are then for LTE FDD. Apply possibly the same philosophy as for BB-PPDR

Other communications

- 5.9 GHz perhaps for hot spots as mentioned in Urban Rail SRDoc (limited range of about 300m)

- Video applications may also be able to use one of the options where PT SE7 is already conducting compatibility studies for cordless cameras and video links such as for surveillance cameras (do not include in the bundle for railway comms). Problem: regulators cannot give each market sector their own 'video' frequencies -> need to differentiate and not bundle everything to be < 1 GHz
- Most radio bricks could provide support LTE on any allocated band. There are presentations from several manufacturers demonstrating that adding bands in the radio module, spanning potentially from 400 to 925 MHz is not an issue, also for the antennas
- Note the many narrowband NB PMR authorisations in the 400 MHz bands (roughly 120,000 throughout Europe -> recent CEPT questionnaire). Difficult to find a common harmonised slot for WB/BB applications.
- Development of a new ECC Report in WGFM / FM54 may include some sections on synergies. Timeline: work by early 2016.

IDATE and WIK Consult conclusions from the workshop

It was noted that several points are linked to railway needs:

- Different lines have different requirements
- Functional requirements are an issue and could evolve
- 99.999% availability is unrealistic; 99.9% might possibly be realistic

Certification of future devices/terminals is an issue as the use of Cognitive Radios is likely to lead to very complex validation processes.

Migrating the applications to IP gets strong support (unanimous vote).

Even though satellite cannot be considered as an option for the entire communications system, MEO satellite could be part of a hybrid solution. Satellite is seen as "better than nothing" for some rural areas.

Most of the stakeholders indicated that co-existence with PPDR and possibly with MNOs should continue to be studied.

- The Finnish case is an interesting data point as the Finnish Infrastructure Manager indicated they will be using TETRA networks for railways communications, but only for voice, not data.
- Roadmap of current NB/WB PPDR: in place at least until 2025/2030

It was mentioned by a participant that there is also an interest to look at business needs but it appears that entertainment services implies different networks.

As far as network costs are concerned, a large fraction of the cost is in cell sites and there is a strong interest from infrastructure managers in re-using them.

As there is pressure from other user, there is a need for the railways sector to be more active in protecting spectrum assets.

2.3. Results of the third workshop

Introduction

Context of the Workshop

The third workshop aims at providing information to the attendees about the analysis done by IDATE/WIK and to discuss the analysis result. The workshop on the 11th of February presented the Interim Report of the study. Some of the points raised various discussions in the room, and the participants had the chance to exchange their views. The Interim Report was published on ERA's web site 2 weeks before this workshop.

The presentation used during the workshop is available on ERA's web site (<http://www.era.europa.eu/Document-Register/Documents/ERA%20Workshop%203%20-%2011%2002%202015%20v9.pdf>).

The draft Final Report of this study will be published in March and it will be open for comments during two weeks. The Final Report will be published on the ERA website around April.

The outcome of the study will be used in the next steps of the ERA Program, to prepare the introduction of the successor(s) of GSM-R.

Wrap-up

Objective of the workshop

The workshop was intended to present the Interim Report – which was made available in January - and to receive comments.

- Provide a summary of information (interviews, workshops, desktop)
 - findings related to these inputs
- Provide information about *decision to be taken* at each Level
 - *What*: technology, spectrum, service provisioning, tools, sharing
 - *By whom*: EU, Member States, external
 - collect feedback
- Provide a summary of *Options*
 - per Analysys Mason (2014), SCF (2014), and this study
 - background, motivation
 - collect feedback
- Provide information on the *Analysis of Impacts* of each Option
 - effectiveness
 - efficiency
 - coherence
 - collect feedback

Summary

Our summary of the most important input from stakeholders appears below.

- We assumed that the main reason to upgrade from GSM-R was eventual obsolescence GSM. However, not all attendees agreed, as other factors may play a role, e.g.:
 - Capacity limitations in e.g. Switzerland and Germany are already a problem, and have motivated agreements with commercial MNOs.

- Interference with LTE may make the GSM-R bands only marginally useful – yet another possible reason to migrate.
- More focus needed on the business case issues, and on risks. (Not clear if we have the right data to do this.)
- Flexibility to support rail business applications is a functional need linked to effectiveness, not just efficiency.
 - E.g. support for M2M for operational maintenance.
- The approach to supported technologies needs some refinement.
- Some aspects are beyond the scope of this study, but we can recommend that the experts study them.
- Specifications should be broad – LTE release numbers will change over time, should be left to the experts.
- A catalogue of technologies of interest should be included, but not more than are needed (interoperability testing, ...)
- Interoperability profiles should be defined by the experts in case multiple technologies are used in the future.
- QoS needs (and other requirements that are not yet addressed in the study) must be worked out by the experts.
- There are also requirements (e.g. QoS) on the IP network (non-radio part).
- A comprehensive study as to whether pure OTT apps (i.e. apps running over a network with no rail-specific enhancements) can satisfy rail operational needs could be important.
- The UMTS / 3G and Wifi in the overview of potential technologies are not clear
- More attention to satellite, including GEOs.
- Opportunity costs discussion needs to reflect the *value* that flows from the GSM-R band.
- Future technologies such as 5G must be considered when the time is ripe.
- E-GSM-R bands may need more attention.
 - Further thought needed on spectrum sharing with LTE (or PPDR)?
 - Who shares with whom?
 - An important asset (e.g. for migration), although not available in many countries
- Voice support – needed in an all-IP world? VoLTE?

Editorial

- Better definition of terms.
- Many clarifications needed in the Interim Report (more detailed definitions, justification for assessment)
- The logic of choices for policy options was not clear – do we have all relevant policy options?

Comments on the presentation of the interim report

[Reference to the document: ERA Workshop 3 - 11 02 2015.pptx](#)

Comments on the scenarios (Slide 33)

Not all Options of interest are present.

The terms used for the options should be clearly defined.

Comments on the spectrum opportunity costs (slide 34)

Many comments revolved around the €2.5 billion opportunity cost alleged to be associated with GSM-R spectrum.

Some attendees asked for a clearer definition of how the opportunity cost was calculated, in order to better understand what the amount refers to (it is calculated using the value that the spectrum band would likely bring at auction).

Comparison with the D-block for PPDR in the USA was discussed. WIK responded that conditions that the US FCC imposed on the D-block likely depressed its value, such that bids did not reach the reserve price.

It was argued that the E-GSM-R spectrum (which is shared with unlicensed devices) does not have the same value as the GSM-R spectrum (which is exclusive spectrum).

Discussion regarding the Multi-technology networks (slide 38)

ETCS is currently experimenting tests with satellite. Using the Inmarsat service in the L-Band (BGAN service) works for ETCS data according to tests carried out in Sardinia in cooperation with cellular networks (detailed information on this test will be provided to the study team).

The results are very encouraging. GEO satellite architecture is sufficient to meet ETCS requirements. Some additional information will be provided. Even though the official results are not published yet, some figures could be disclosed for now. No technical bottleneck has been found during the tests.

Discussion regarding the different criteria for the assessment (slide 44)

Some participants felt that use of the same network for rail business applications such as maintenance (an M2M application) were not adequately taken into account, nor was their traffic reflected. WIK noted that support for rail operational applications were treated in the report as a mandatory requirement, while support for rail business applications as an optional requirement that could enhance the cost-effectiveness of a solution.

Clarification about the word “enhancement” is needed.

Someone noted that his comments are not meant to challenge the report but aim to complement it.

There was extensive discussion of new demand for new functionalities. Some new data applications can already be offered by GSM-R evolution, with E-GPRS. As in several of the written responses to the Interim Report, several attendees argued in effect that it is backwards to argue that no more bandwidth is needed but no new application requirements are visible. They claim that no new applications are emerging because bandwidth is so scarce in the current system as to make additional functionality unthinkable.

Comments around the assessment of impacts at the Member State level (slide 48)

Someone from the floor argued that there was a mistake regarding the security parameter (slide 47 - there should be no “minus”).

Quality of service (QoS) criterion is missing in the table. Nevertheless, it has to be determined what kind of (realistic) QoS parameter should be taken into account. It was stated that the GSM-R technology continues to evolve with improvements of the standard.

Discussion around the “++” in the “functionality” assessment.

GSM-R: layers 1 to 3 (physical, data link and network layers) should be addressed in the standardisation.

Discussion regarding elements of the preferred Option (slide 52)

A first comment suggests the list should integrate the LTE Release 14 as well.

Tests carried out with GPRS for railways provided a useful list of tests which could be used for other technologies. A catalogue of usable technologies, frequencies and requirements could be established. ERA should be the authority to manage that.

Another comment raised the question of the future of the voice technology in a successor to GSM-R. How should it be implemented? Will voice be distinct from data? How will special GSM-R voice features be dealt with in a future system?

VoLTE functionality was suggested. Some attendees said that it is not critical, because all that people want is “a big IP pipe”.

Some people want more clarification about the term “preferred”.

One topic alleged to be missing is the IP network requirements. WIK asked if QoS (as in the ToS bits in IPv4) was an example of something that is needed, but not fully standardised in TCP/IP standards, and the speaker agreed.

Regarding QoS, concerns were raised that prioritisation might be difficult to implement due to future net neutrality obligations.

Nevertheless, numerous people in the audience viewed QoS as very important for mission critical applications.

For ETCS, 3G/UMTS is felt not to be a long-term solution.

The mix of technologies that will be used by railways should refer to a common catalogue of technologies (that should be achieved by ERA).

Comments on the key findings session

Questions at the MS level (slide 57)

What are realistic timeframes in which the different technologies can be used in a supported operational condition (development, start and end of deployment)

No comment.

Is the satellite timeframe realistic (having MEO satellite capacity available in 2030)?

MEO satellites could be deployed in the shorter term (i.e. before 2030) when there is a clear request from the market. Satellite is seen as a complement to other network technologies such as GSM-R; however, standalone use of satellite could not meet ETCS requirements.

The future network likely requires a mix of technologies.

Cost drivers: can we consider that infrastructure costs (cell sites, transmission...) are sunk costs for Infrastructure Managers?

It seems that people were unanimous to say "yes".

Should we assume a need to support speeds up to 500 km/h? LTE is limited today to speeds of 350 km/h. How can the industry address this issue? How long would it take?

A first comment suggested assuming the speed limit at 500 km/h, as it seems that we do not have any estimates regarding the implementation of high speed lines and the time frame.

Someone commented the Italian case where the current speed is around 260 km/h. He predicted that the speed could reach 400 km/h, as it is a commercial target. Currently the TSI's refer to 500 km/h, although the real maximum operational speed used is 350 km/h, adding 10% margin.

Other people remarked that there is a technical paradox: LTE speed is greater in the city than in the countryside, whereas train speed is higher in the countryside than near the city. This is not always the case (i.e. high speed train running at full speed in a stretch of line inside the urban area).

Will all trains have to support all technologies employed in Europe in the future?

Here, representatives from Railway undertakings warned to pay attention of the costs, referring the question of business cases. From the perspective of the equipment suppliers, the number of solutions must be strictly limited, otherwise the costs would go through the roof. Some IM attendees disagreed, and argued that costs per supported configuration are low. Marcus would claim that, when costs such as certification are factored in, it is clearly important to keep the number of configurations to a manageably small number.

Will it be possible to have the same functionalities as on future LTE networks using OTT applications on all-IP networks (such as satellite networks of Wi-Fi networks)?

The "OTT" term needs to be better clarified, as many people were not familiar with the term.

According to some attendees, it is not just a question of functionalities but mainly a question of QoS.

Someone added it is still a question of cost as well.

Is support for UMTS warranted, or should it be leap-frogged?

People seem to be agreed on the fact that 3G will be shut down before 2G. In the morning, most attendees seemed to see little need to incorporate 3G support into a GSM-R successor; in the closing session, however, a number spoke up in favor of 3G support.

How realistic is reliance on GSM-R Evolution?

People comment that all railways will migrate in the next 4 years and GSM-R will continue to evolve towards IP.

Nevertheless, it was mentioned that the pace of migration for ETCS is still very low. There is a risk that technology will not be supported anymore.

Comment on the impact assessment (slide 58)

Functionality: Do you agree that Enhanced commercial mobile networks and Hybrid networks will be much better than the baseline?

A clear definition of “enhanced commercial mobile networks” was requested. F. Pujol indicated that it refers to a commercial MNO with for example additional sites to provide a better coverage.

A person from the audience said that it is more a legal discussion than a technical discussion.

A question has been asked regarding the scope of the question whether it relates to voice or ETCS data only.

A person claimed that there is no extra functionality requirement.

Capacity: Do you agree that unmodified commercial mobile networks, Enhanced commercial mobile networks and Hybrid networks will be much better than the baseline?

Yes.

Ease of use: Do you agree that unmodified commercial mobile networks will be much worse than the baseline?

A comment wants to redefine “worse”.

Majority of people answered the question positively.

Network CAPEX: Do you agree that unmodified commercial mobile networks and Hybrid networks will be much better than the baseline?

Here, “much better” means “much cheaper” for comparable capability.

Someone pointed out the lack of coherence with the table including the qualitative results (++ , -- , etc).

Other people commented that it will be cheaper for the society but it does not mean it will be cheaper for the railway companies.

Finally, a person noted that the network OPEX will be higher.

Opportunity to support other services: Do you agree that unmodified commercial mobile networks and Enhanced commercial mobile networks will be much better than the baseline?

YES

Manageability: Do you agree that unmodified commercial mobile networks will be much worse than the baseline?

Some people admitted that it is difficult to answer this question.

It should be “worse” but not “much worse”.

Someone made a general comment:

- “much” should be avoid
- It is not “black or white”
- It also depends on the country

Discussion around GSM-R spectrum and future topics (slide 60)

Is anyone aware of likely action at European or Member State level that challenges our assumption that the current GSM-R band will continue to be available in Member States that wish to continue to use it for GSM-R through 2030? Do you agree that E-GSM-R spectrum (873-876 MHz (Uplink) and 918-921 MHz (Downlink)) is in danger?

The GSM-R band should rather be considered as an important asset (e.g. for migration).

E-GSM-R: it would be useful to know who shares with whom?

What other topics would you like to investigate in the future?

There should integrate the costs and benefits for the railway sector into the impact assessment.

Upgrade of technology: it should include social impact like training sessions and competences/skills IDATE mentioned that it is addressed in the “social impacts” session.

Future steps

- The draft Final Report of this study will be published in March
- The draft Final Report will be open for comments during two weeks.
- The Final Report will be published on the ERA website around April.
- The outcome of the study will be used in the next steps of the ERA Program, to prepare the introduction of the successor(s) of GSM-R.

3. Annex 3 – General Background

3.1. How railways see the evolution of GSM-R

This section is based upon inputs from various sources: we used our desk research, the interviews carried out with the railways and telecommunications stakeholders and the comments and feedback we had during the two workshops in Lille and Valenciennes.

3.1.1. GSM-R and the need for a successor

More than twenty years ago, GSM was chosen by the UIC as the radio technology for a pan-European mobile railway network. This choice was reaffirmed in 1995, and led to the first deployments in the years 2000. At that time, the idea was to rely on a standardized technology, while bringing unique features that commercial technologies did not offer. Historically, national railways had indeed been relying on often country-specific and proprietary technologies with little to no competition on the equipment market and more importantly no interoperability between existing systems.

Technologically speaking, it differs very little from GSM and has additional features similar to technologies used by PPDR forces. Those specific features are mainly advanced speech call capabilities such as voice call group services; voice broadcast service, emergency calls or specific numbering features. Users can for instance be reached according to their functions rather than by their number. ETCS (European Train Control System) Level 2 uses the GSM-R network to transport the data for the control of the movement of the train. For the GSM-R network, the ETCS L2 application is a user. It is devised as to enable guaranteed performance at speeds up to 500 Km/h.

While GSM-R has since then proven its reliability and usefulness in the day to day operation of railways in Europe and worldwide, the increasing reliance on data to improve security of trains and passengers and manage traffic effectively raises the question of the technological and economical evolution of GSM-R. Behind the question of the technology is also raised the question of the control of such network.

It is likely that the railways features could be moved to the application layer without relying on the network features. So the fact that some critical features are currently not supported by deployed LTE networks (although work is under way in Release 12 and onwards), could enable railways companies to rely on commercial cellular networks with specific features.

Blue light forces for instance see a clear interest in many broadband applications in their daily work, but are not able to use them because of technology limitations.

This scenario is probably extreme, but paves the ways for further reflections on intermediary situations where specific networks for specific users could be operated differently and so could be providing specific services such as QoE, voice group calling, instant emergency signaling. While usage and requirements vary from one sector to another, challenges converge, at a time where new technologies enable new innovating applications. How to leverage on such capacity and latest technology developments while enabling secure, 7 days a week, 24 hours a day operational networks?

In other sectors, examples exist of PPDR networks operated by a third party and acting as a MVNO to provide mobile broadband services. This is the case in Belgium for instance where the national emergency network is partly run as a MVNO, providing a TETRA network to the PPDR forces while offering 3G data with preferential access and services through agreements with all Belgian mobile network operators. Other examples exist in the UK (Airwave) or in Finland where VIRVE network operates a TETRA networks as an MVNO to Finland's authority. This example is interesting because the Finnish railway is studying the possible use of VIRVE instead of GSM-R for voice communication.

As GSM-R will become obsolete with an end of life expected in 2030 in Europe, its successor should probably be defined in such a way that it takes into account the existing assets (cell sites, transmission links...) and a realistic transition period for European infrastructure managers.

The new radio systems will have to be integrated in the TSI (Technical Specification for Interoperability) from 2018.

Some GSM-R drawbacks are mentioned by stakeholders:

- Long call procedure is mentioned by UNIFE (the Association of the European Rail Industry)⁴;
- Heavy ETCS traffic is already observed in dense areas and congestion is happening in some places. Use of the GSM-R spectrum can be seen as “sub-optimal” compared to the latest mobile technologies and current use of data over circuit-switch limits the number of trains to be controlled in station areas. The use of packet switched sub-system with GPRS is however expected shortly.

UNIFE also states that backward compatibility is key in order to preserve investments made by railways and suppliers.

3.1.2. Future railways communications functional requirements

The study of functional requirements is out of the scope of this study, although they are taken into account. The ERA Ex-Post analysis of the use of GSM-R confirms no additional functionality is requested by railways.

The roadmap for future European railways standard has to be prepared taking into account the requirements from the railways and the current evolution of other radio systems. The feedback we had during the two workshops in 2014 are that the current functionalities should pretty much remain the same, even if there might be some enhancements.

General requirements – data services

On top of the requirements mentioned below, it was also underlined by some railways stakeholders that functional requirements are an issue and could evolve. Our analysis takes into account existing functional requirements as it is expected that the outcome of the work carried out jointly by ERA and UIC will be available after the end of our study.

UNISIG, which is in charge of the development of the ERTMS specifications jointly with ERA and railways, states⁵ the following communication requirements for ETCS data:

- Interoperability: within and across countries;
- Availability: following operational needs;
- Timeliness: short connection, transfer delay;
- Priority: precedence over non-ETCS data;
- Backwards compatibility: long life cycle;
- Migration: GSM-R and new radio co-existence;
- IP-based: independent from radio bearer;
- Security: in case of hacking, denial of service. The move to IP raises security issues among railways stakeholders;
- Expandability: ready for traffic increase;
- Maintainability: performance monitoring between trains and tracks.

UNISIG also mentions the “exportability” for markets outside Europe, but this is out of the scope of this study.

⁴ This statement was published by UNIFE: UNIFE vision about the future communication system for ETCS and the Railway signaling system - Michel Van Liefferinge - 12th of November 2014

⁵ UNISIG - Radio Communication Evolution – ETCS criteria - Support to ERA workshop on the evolution of railway communication system 26th November 2014

Other requirements mentioned by the stakeholders during the workshops are the following:

- Ease of use: It was reported there is a strong requirement to make the system as simple as possible. The term “plug and play” was even mentioned.
- Traffic prioritization: the selected system needs to be able to control traffic overload and manage communication priorities. A specific criteria on this topic needs to be created.
- The services needed by the railway community have to be traceable, contractable. If not, the services fail in compliancy requirements.

The need for video is not strong according to the interviews we carried out with the stakeholders: some players indicate it might be needed for ATO, for telemaintenance, maybe some M2M applications but it is not expected demand will be massive and it will probably not be needed on all lines (then not a minimum requirement for interoperability).

IP-based system

As for the migration of existing assets (infrastructure), it was massively highlighted during the interviews that the GPRS trials for ETCS 2 might be a first step towards IP. Some railways also expect a reuse of existing infrastructures for the future system to be implemented.

In the future, ERTMS shall be based on IP communication principles, while offering “backwards” compatibility. Voice applications also have to be included in the future.

The need for a future-proof communications system

The future railways communications system should be future-proof and be up-to-date in terms of technology. This means that the future system should be based upon packet transmission and IP. The need for an IP-based bearer-independence is important. It was expressed by many participants of the first workshop that the future radio communications system should be based on a radio bearer independent of the application layer: the IP layer should be transparent from the radio access bearer. This will enable a smooth transition and will provide a future-proof solution. There is a general agreement on the fact that introducing IP as overall bearer offers all flexibility, scalability, capacity, availability and performance Railways need. The industry needs to develop IP suitable Voice and ETCS application platforms.

Migration issues

UNISIG provides its vision for the first steps on the evolution and migration to IP of the ETCS:

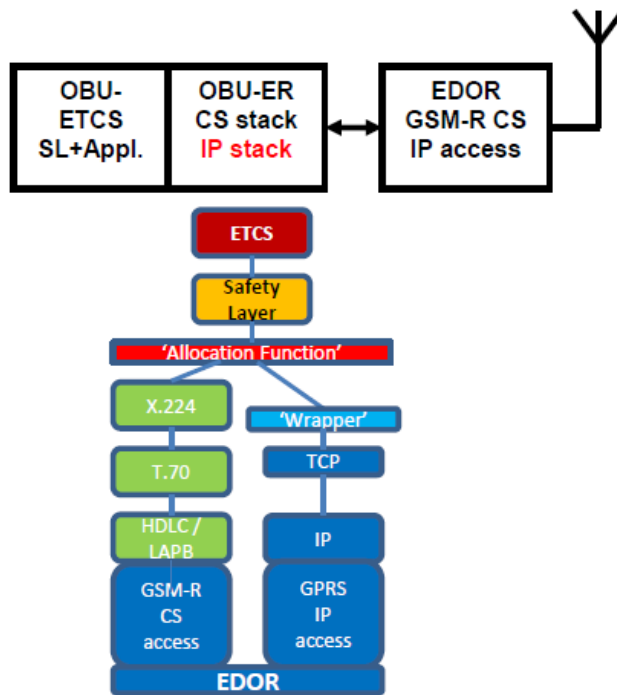
Figure 4: Migration to IP

Source: UNISIG

UNISIG states that ETCS over GPRS is the first step (dual Euroradio protocol stack) for the IP migration. Harmonization of Railway IP network is required for IP addressing (Domain Name...), IP security norms and IP mobility. UNISIG estimates that the evolution towards an IP network will require the same level of performances as GSM-R. ETCS shall rely on IP Service Level Agreements (SLAs) with flexible performance requirements based on Subset-093 for all cases including:

- Radio technology, frequency band (GSM-R/GPRS, 4G, 5G ...)
- Ownership of radio access infrastructure (private, public)
- Operational context (high speed, sub-urban, ATO ...)

OBU (On-Board Unit) Euroradio should support dual stack CS (Circuit Switched)/IP during the migration process and EDOR (ETCS Data Only Radio - On-board Radio) modems should become IP routers.

UNISIG also presents its view of the future architecture in order to enable a smooth migration from GSM-R to the future IP-based communications system:

Figure 5 : ETCS data - architecture view

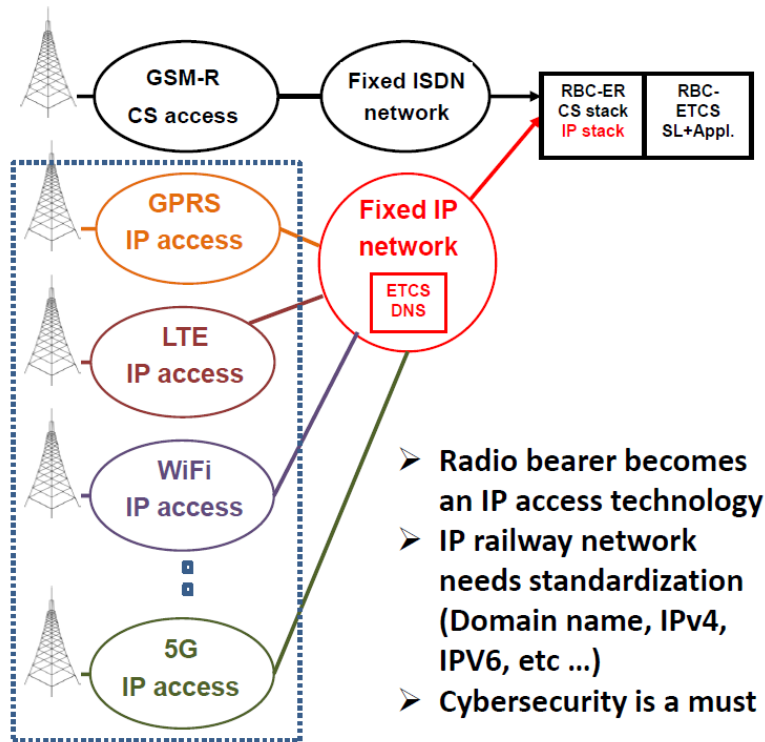

Source: UNISIG

It was mentioned that the migration process should be a step-by-step one and that practical implementation should be kept in mind. A major part of the existing GSM-R equipment could be reused for the future system (cell sites, backhauling links...).

Ownership and control of the communications network

Ownership and control of the communications system is a very important aspect for infrastructure managers. As a matter of fact, owning the network allows the Infrastructure Manager to control the functionality, and also control the future evolution of the communications network.

The following questions are to be addressed:

- Is a dedicated private network needed for the railways community?
- The answer will directly impact the analysis, beyond reviewing the possible options
- If the network is not owned, how to influence the wished evolutions of the network following new requirements (how to control functionalities available on the network)?

Devices

Devices installed in the locomotives should be able to support both GSM-R and the future communications system(s). Cognitive radios are seen as a solution in order to adapt to multiple frequency bands and radio interfaces that could be used by railways in the future.

Railways stakeholders fear that even if cognitive radios will be available by 2020, the railways sector will have difficulties to certify such equipment (too expensive). Moreover, the certification of devices (software) could be complicated, as there will probably be different network models depending on the lines considered.

Nokia stated during the second workshop that the most important feature is that the on-board system can sustain all frequency bands.

UNISIG also states⁶ that on-board radio (EDOR) becomes critical equipment:

- To ensure radio bearer independency
- To manage IP mobility and interoperability (IPv4, IPv6)
- To monitor the Train communication performances (according SLA)

Railways requirements per type of line

The different line categories and their different requirements (voice, voice + ETCS, low density lines) will lead to different network models.

RFF indicated that it is already the case today: GSM-R is used in 50% of the network, and public roaming for the remaining 50%. Italy and Switzerland also use public roaming today.

There is best effort coverage on some lines and it is expected that this will continue in the future.

Railways requirements depend on the type of line:

- high-speed or conventional;
- freight or passenger traffic;
- high or low density.

QoS and QoE considerations

Quality of Service (QoS) parameters and mechanisms are important to enable network operators to design, build and manage their networks, but they are not directly visible to end-users.

Avoid gold-plating

It was indicated during the first workshop that the solution should be chosen depending on an optimized trade-off between costs and QoS. Under “avoid gold-plating”, we mean that a given solution offering a 99.5% availability rate might be more relevant in the assessment if it is, for instance, two times cheaper to deploy than another solution offering a 99.8% availability rate. Availability rates are also strongly tied to the nature of the line. RFF indicates as an example that availability rate of GSM-R is 99.99%, 99.91% for critical voice locations, and 99.51% for other voice locations. Another way of approaching this question is to distinguish technical availability between equipment (99.99%) and radio-availability (99.5% - time/place).

Crucial for end-users, however, is the quality that they personally during their use of a service. These *Quality of Experience (QoE)* requirements are strongly dependent on the application. Some are sensitive to delay.

⁶ Radio Communications Evolution – ETCS criteria – support to ERA workshop – 26 November 2014

4. Annex 4: Background information on railway lines & ERTMS implementation

It is important to understand that not all railway lines have the same requirement depending on multiple criteria Such as what is transported over them (freight or passengers), the maximum speed of the line, the density of traffic. Initially only mandatory for lines part of the Trans European Network (TEN), GSM-R and ETCS were finally required to be also deployed on off-TEN lines.

This new requirement, brought by an amendment to the CCS TSI bring new complexity, since the evolution of the system will have to take into account more divers lines

GSM-R deployments

In 2013, there was around 100,000 km of lines in Europe covered by GSM-R according to ERA data. This is only an estimate as data for some small countries are unavailable. Ultimately 150,000 km of lines in Europe are to be covered by GSM-R

Table 2: Number of km of lines covered by GSM-R

Country	Km with GSM-R
Austria	3 290
Belgium	3 000
Bulgaria	70
Switzerland	2 318
Czech Republic	1 130
Germany	28 541
Denmark	-
Estonia	
Greece	707
Spain	2 239
Finland	5 096
France	5 782
Croatia	Na
Hungary	Na
Ireland	
Italy	11 200
Lithuania	1 563
Luxembourg	
Latvia	
Netherlands	3 110
Norway	3 800
Poland	82
Portugal	40

Country	Km with GSM-R
Romania	40
Sweden	11 000
Slovenia	-
Slovakia	
United Kingdom	15 108
Total	98 116

Source: ERA

ETCS

The European Train Controlling System currently covers 4% of the European railway network, i.e 9,462 km of lines, mainly on the part of the network that are used by cross border services and high speed services. ETCS can be deployed with different level

- At level 1, GSM-R is not generally required to transmit the ETCS data (unless if radio infill devices are used), and other technologies such as analogue radio, balises or inductive loops are used to transmit the signaling data to the train.
- At Level 2, GSM-R is used for the communication between the train and the signaling control center.
- At Level 3, which is standardized but which has actually few implementations, sensor and radio-based train spacing are used to prevent two trains from moving on the same block at the same time

On the 19th of November 2013 new TEN-T guidelines were approved by the European Parliament, stating that ERTMS should be set in to operation on each member states "core network" by 2030. By 2050, this is the "extended" rail network that should have ERTMS implemented. Currently, the technologies used for automatic train control are very different from one country to another. They are usually old technologies. Even within a same country, multiple technologies are used.

The deployment of ETCS has started 15 years ago but the number of km of lines equipped is still limited. Among European countries, Spain is by far the most advanced countries with more than 1,300km of lines equipped with ETCS Level 1 and 700 km of lines equipped with ETCS Level 2.

Because by 2050, other technology than GSM-R may have started to be used in Europe, it is important for ETCS to be able to be separated from any specific bearer so that it can easily be supported by the technologies used.

Table 3: Track km with ETCS in service, as of mid-2013

Country	Number of km covered by ETCS
Austria	496
Belgium	446
Bulgaria	387
Croatia	0
Cyprus	0
Czech Republic	22
Denmark	0
Estonia	0
Finland	50

Country	Number of km covered by ETCS
France	405
Germany	823
Hungary	280
Ireland	0
Italy	947
Latvia	0
Lithuania	0
Luxembourg	275
Malta	0
Netherlands	365
Norway	285
Poland	310
Portugal	0
Romania	311
Slovakia	635
Slovenia	615
Spain	2112
Sweden	480
United Kingdom	218
Total	9462

Source: SCF report for the European Commission

T.E.N lines

The Trans European Network is a multi-modal network in Europe made up of 136 706 km of roads, 23 506 km of inland waterways and 136 706 km of railway lines.

Over the 236 884 km of lines in 2020, around 50% of them will be part of the TEN

Figure 6: Share of TEN lines in 2020

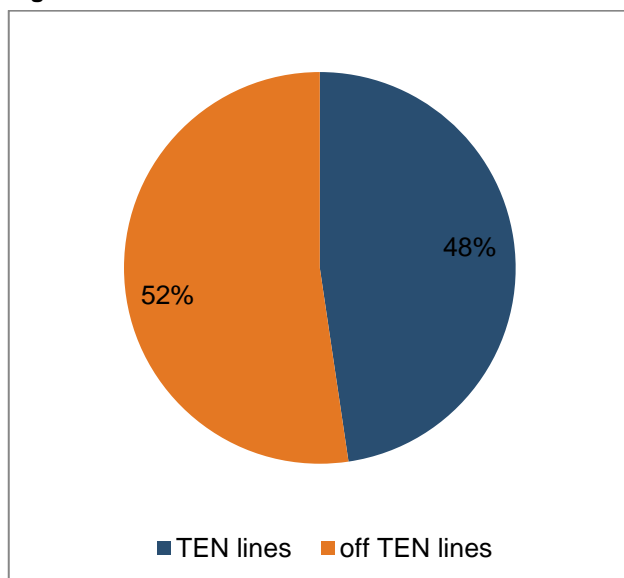

Source: EC

Conventional rail vs high speed line

All high speed lines are part of the Trans European Network. The share of high speed line within the Trans European Network is estimated to reach 29% of km of lines in 2020. If we compare the number of km of high speed lines to the total number of km of lines in Europe (i.e. both within and outside TEN lines), high speed lines account for 13% of the total. This means that the fact that CCS TSI will apply to both TEN and off-TEN lines starting the 1st of July 2015 won't change much regarding high speed lines, since they are all already covered by CCS TSI.

Figure 7: Share of km of high speed lines and conventional rail in Europe as forecasted in 2020

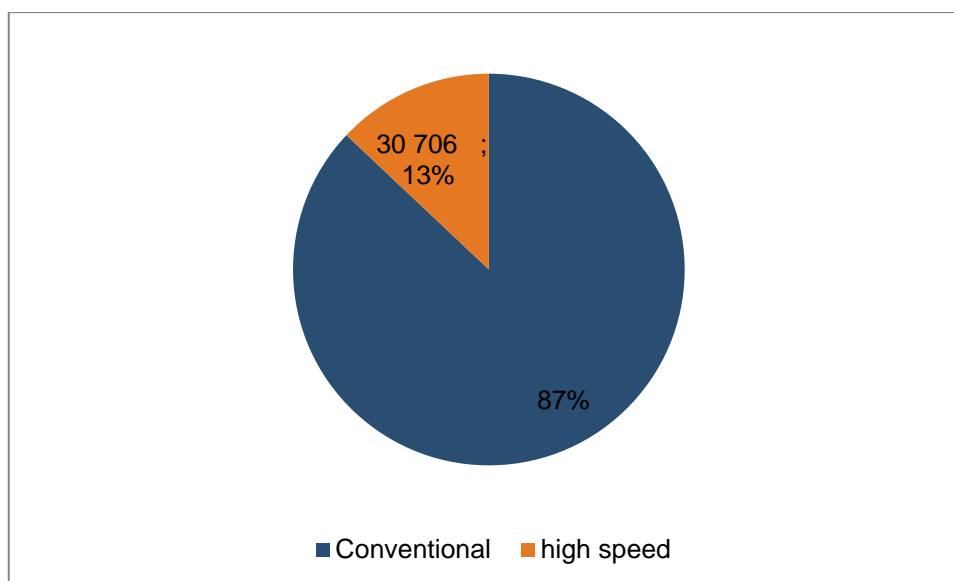

Source: IDATE based on ERA - IU-ExtScope-20090807-FinalReport-Annex01_1-Inf.xls

Table 4: Quantitative comparison of TEN and off-TEN by length (km) of line, as forecasted in 2020

TEN lines	High Speed			Conventional Rail			Total
	TEN	off ten	Total	TEN	off-ten	Total	
Country							HS + CR
AUSTRIA	1720	-	1720	1510	2920	4430	6150
BELGIUM	551	-	551	1632	1707	3339	3890
BULGARIA	-	-	-	2366	1780	4146	4146
CZECH REPUBLIC	100	-	100	2324	7172	9496	9596
DENMARK	-	-	-	944	1189	2133	2133
ESTONIA	-	-	-	692	270	962	962
FINLAND	-	-	-	3980	1539	5519	5519
FRANCE	4843	-	4843	11062	13558	24620	29463
GERMANY	5812	-	5812	10611	29552	40163	45975
GREECE	935	-	935	1615	135	1750	2685
HUNGARY	-	-	-	2846	5118	7964	7964
IRELAND	-	-	-	1319	600	1919	1919
ITALY	4270	-	4270	5996	8419	14415	18685
LATVIA	-	-	-	1340	929	2269	2269
LITHUANIA	-	-	-	1036	816	1852	1852
LUXEMBOURG	20	-	20	197	78	275	295

NETHERLANDS	360	-	360	1691	1085	2776	3136
NORWAY	-	-	-	3211	876	4087	4087
POLAND	308	-	308	4924	14505	19429	19737
PORTUGAL	1013	-	1013	782	1057	1839	2852
ROMANIA	-	-	-	3340	7441	10781	10781
SLOVAKIA	-	-	-	1417	2209	3626	3626
SLOVENIA	181	-	181	434	794	1228	1409
SPAIN	7086	-	7086	6138	6916	13054	20140
SWEDEN	1600	-	1600	3181	6688	9869	11469
UNITED KINGDOM	1907	-	1907	7600	6637	14237	16144
Total	30706	-	30706	82188	123990	206178	236884

Source: ERA - IU-ExtScope-20090807-FinalReport-Annex01_1-Inf.xls

Track gauge

All high speed tracks have the same standard gauge of 1,435 mm and most of conventional rail use this gauge. In 2020, it is estimated that 88% of km of lines in Europe will be of 1,435 mm.

Long distance and regional tracks

A research made by the European Rail Research Advisory Council in 2006 indicated that around 185,000 km of lines where regional lines, as compared to long distances lines

Motor Units

Most services are run in regional lines, something that is mirrored in the repartition of motor units in the table below. Indeed, European wise, High Speed trains only accounted for 2% of the total number of motor units in 2005, as shown in Table 5: Fleet of rolling stocks in European countries excluding passengers vehicles, as of 2005. Figures however vary since another report estimates the share of high speed rolling stocks excluding passenger coaches to account for 13% of all rolling stocks. It is to be noted that it is not very clear from the report whether urban rail rolling stock is included or not, even though UITP is mentioned in the report.

Table 5: Fleet of rolling stocks in European countries excluding passengers vehicles, as of 2005

	Locomotives	Conventional Rail Electric Motor Units and Diesel Motor Units	High Speed trainsets	Total
Austria	1387	428	-	1815
Belgium	759	759	11	1529
Bulgaria	602	97	-	699
Czech Republic	2167	999	3	3169
Denmark	117	401	-	518
Estonia	113	57	-	170
Finland	545	157	11	713
France	4593	3936	391	8920
Germany	5635	8362	215	14212

	Locomotives	Conventional Rail Electric Motor Units and Diesel Motor Units	High Speed trainsets	Total
Greece	164	125	-	289
Hungary	1006	477	-	1483
Ireland	94	318	-	412
Italy	3402	2018	95	5515
Latvia	205	148	-	353
Lithuania	240	125	-	365
Luxembourg	96	49	-	145
Netherlands	121	1957	10	2088
Norway	120	187	36	343
Poland	3817	1448	-	5265
Portugal	155	302	10	467
Romania	1975	287	-	2262
Slovakia	1059	249	-	1308
Slovenia	149	112	3	264
Spain	658	1237	140	2035
Sweden	533	480	50	1063
United Kingdom	930	2900	226	4056
total	30642	27615	1201	59458

Source: IU-ExtScope-20090807-FinalReport-Annex01_2-LocPas.XLS

From a CCS TSI perspective, it should be noted that it is difficult to know exactly how rolling stocks are shared between on and off TEN networks since many rolling stocks are used on both type of lines

Figure 8: Share of each type of rolling stock in the European fleet (2005)

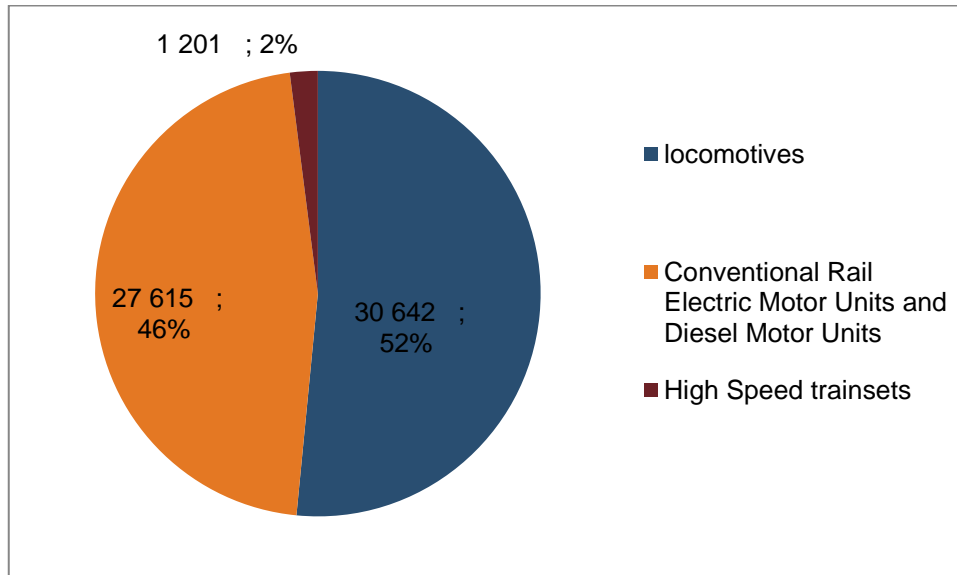

Source: IDATE based on IU-ExtScope-20090807-FinalReport-Annex01_2-LocPas.XLS

5. Annex 5 - Factors that influence the impact of each Option

Within the framework of the cross-sectoral and rail-specific Options and Sub-Options put forward in Chapter **Error! Reference source not found.**, a number of apparently crucial questions emerge. These questions include:

- Must GSM-R be supported?
- Must MNO technology be supported without rail-specific adaptations? If so, which MNO technology (and in which spectrum bands)? LTE, LTE Advanced, 5G?
- Must technology and spectrum of a joint PPDR broadband network (possibly also integrated with energy) be supported?

During the two workshops organised in 2014, it was mentioned by railways stakeholders that co-existence with PPDR and possibly with MNOs should continue to be studied. This chapter analyses the various factors associated to the use of such networks.

5.1. Spectrum aspects

A complex landscape to deal with PPDR spectrum

Regulation involves a number of authorities at international level. Many bodies are involved in the PPDR spectrum harmonisation process.

- The ITU is the United Nations agency for ICT.
- The European Commission is setting out policy priorities and long-term objectives for wireless broadband, including PPDR. The RSPP mentions in Article 8.3:

“The Commission shall, in cooperation with the Member States, seek to ensure that sufficient spectrum is made available under harmonised conditions to support the development of safety services and the free circulation of related devices as well as the development of innovative interoperable solutions for public safety and protection, civil protection and disaster relief.”

Figure 9: Bodies involved in the PPDR spectrum harmonisation process

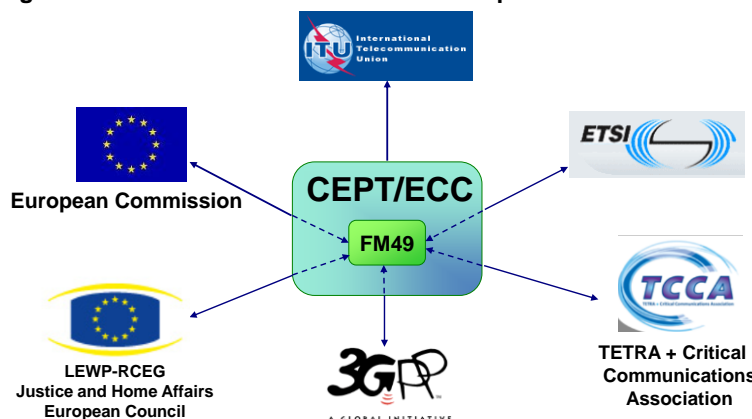

Source: ECO, European Communications Office

- The Radio Communications Expert Group of the Law Enforcement Working Party (LEWP-RECG) is composed of senior representatives from PPDR agencies and regulatory authorities of EU and EFTA Members. It adopts statements setting out mid-to-long-term objectives based on the needs of European PPDR community.
- The ETSI develops harmonised standards for telecommunication equipment, including public safety. ETSI is developing technical reports which both support the standardisation work and the spectrum management activities of CEPT, such as SRDoc.
- 3GPP provides technical environment for producing LTE specifications, including public safety.

3GPP TSG Services and System Aspects (TSG-SA) group is working on the inclusion of PPDR specific features in 3GPP Release 12 (target date: September 2014), namely:

 - Mission-critical voice and data PTT group communication capability (GCSE_LTE), and
 - Direct device-to-device communications (ProSe)
- The TCCA is a forum for all professional users both public safety (mission critical) and utilities and transport (business users). It communicates its needs from 'first hands' to regulatory bodies (CEPT first of all) to ensure timely allocation if sufficient resources.
- Broadband PPDR is one of the priority topics of the CEPT/ECC alongside the digital dividend, cognitive radio, innovation above 40 MHz, numbering and naming, and improving its own working process. WG-FM (with FM49), WG-SE, ECC PT1 and CPG PTD, CPG PTA are the names of the working groups dealing with broadband PPDR.

Figure 10: CEPT groups dealing with broadband PPDR

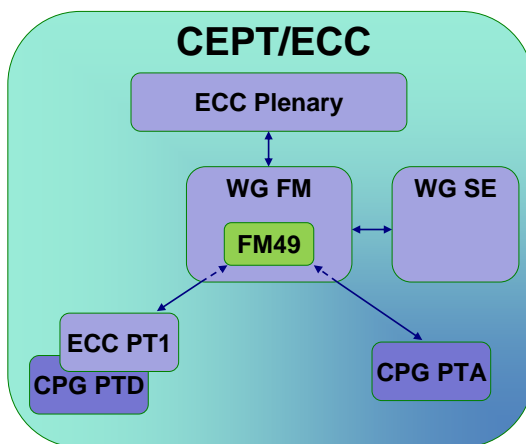

Source: ECO, European Communications Office

FM49 is the PPDR specialist project team of CEPT/ECC. Its main task is to find a harmonised radio spectrum for future European broadband PPDR systems. The ECC Report A setting user requirements and spectrum needs for future European broadband PPDR systems was released in May 2013. The ECC Report B which is expected to follow with solutions is scheduled for early 2015.

FM49 is also supporting the ECC PT1 working group on PPDR parameters for CEPT report in response to European Commission Mandate on 700 MHz and the CPG PTA in the preparatory work of CEPT on Agenda item 1.3 of WRC-15.

PPDR needs and spectrum demands are growing

The need for spectrum suitable for the support of emerging broadband applications for PMR and PPDR applications has been recognised for many years.

It is agreed by operators, users, manufacturers and official committees that a minimum 2 x 10 MHz for broadband PPDR spectrum below 1 GHz internationally harmonised and assigned to broadband data PPDR communications (2 x 10 MHz are already available in the

USA and potentially in Canada, 2 x 10 MHz expected in Europe, 2 x 45 MHz with the APT plan).

Figure 11: Frequency bands targeted by Agurre for high speed data professional radio networks

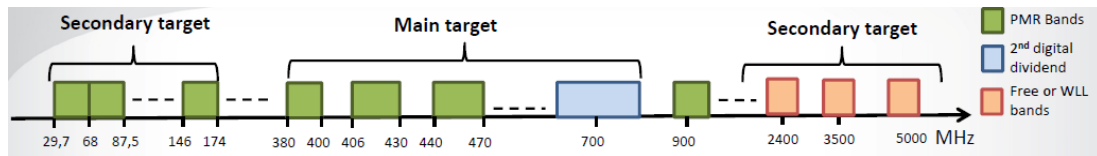

Source: Agurre

400 MHz band

In Region 1 (Europe, Russia, Africa and Middle East), there is a majority of dedicated networks to provide narrowband mobile communications using voice-centric Private Mobile Radio (PMR), Private Access Mobile Radio (PAMR), digital technologies including DMR, TETRA or TETRAPOL, APCO P25⁷ operating in the 380-400 MHz band (2 x 5 MHz in 380-395/390-395 MHz), 410-430 MHz and 430-450 MHz.

Broadband PPDR spectrum in the 700 MHz band

The 700 MHz band is potentially crucial for PPDR and other mission critical applications. PPDR broadband spectrum had been already reserved for construction of LTE networks in some countries (USA, Canada, Australia, UAE) and regions (Americas, Asia, parts of the Middle East) in the 700 MHz.

In Europe, the question is being debated: the channelisation of the 700 MHz band has not yet been finalised. At least, a part of the free spectrum enabled by digital TV services should be reserved. The 400 MHz is also considered in combination with the 700 MHz.

Channelling arrangements considered:

CEPT supports studies on channelling arrangements for the mobile service, which should take into account any asymmetry of traffic loads and achievable bitrates in the uplink and downlink to facilitate an optimal frequency usage.

Further, CEPT supports other usages (including PPDR, SDL, PMSE and PPDR DMO) in the remaining spectrum of IMT channelling arrangements (duplex gap, guard band) to ensure efficient use of spectrum.

A few potential channelling arrangements are currently under study within CEPT:

- *Option 1 in the 700 MHz*: 2 x 30 MHz. This proposed band plan extends over the same frequency range aligns with the lower 2 x 30 MHz duplexer of the APT 700 MHz band plan (703-733/758-788 MHz). This band plan provides 60 MHz of spectrum for IMT.

This option provides a high possible degree of harmonisation with the APT band plan, which will allow having the benefit of economies of scale and roaming capabilities across all ITU Regions.

- *Sub Option 1.1 in the 700 MHz* proposes dedicated spectrum of 2 x 5 MHz for PPDR and 2 x 3 MHz for other services/applications (potentially PPDR) in addition to 2 x 30 MHz for IMT. The duplex gap is smaller than in Option 1. There is a much potential harmonisation with the APT plan, as in Option 1.
- *Sub Option 1.2 in the 700 MHz* is based on Option 1 but the spectrum available for IMT is increased by adding supplementary downlink. This could be aggregated with, for example, the 800 MHz band plan. There is a large potential degree of harmonisation with the APT plan as in Option 1.
- *The band above 790 MHz* harmonised in CEPT for commercial mobile networks could, in the current view of FM49, be considered by those countries opting for a commercial or

⁷ Project 25 (P25 or APCO 25) is widely defined as a suite of standards for digital radio communications for use by Federal, State/province and local public safety agencies in North America to enable them to communicate with other agencies and mutual aid response teams in emergencies. In this regard, P25 fills the same role as TETRA protocol in Europe, although it is not interoperable with it.

hybrid BB PPDR solution, including possible use of a commercial network as backup solution or capacity reserve. Such use is already possible on a national basis, subject to availability of appropriate PPDR terminal equipment. However, it may not meet the requirements for mission-critical operations and interoperability.

Figure 12: Potential channelling arrangements in the 700 MHz within CEPT

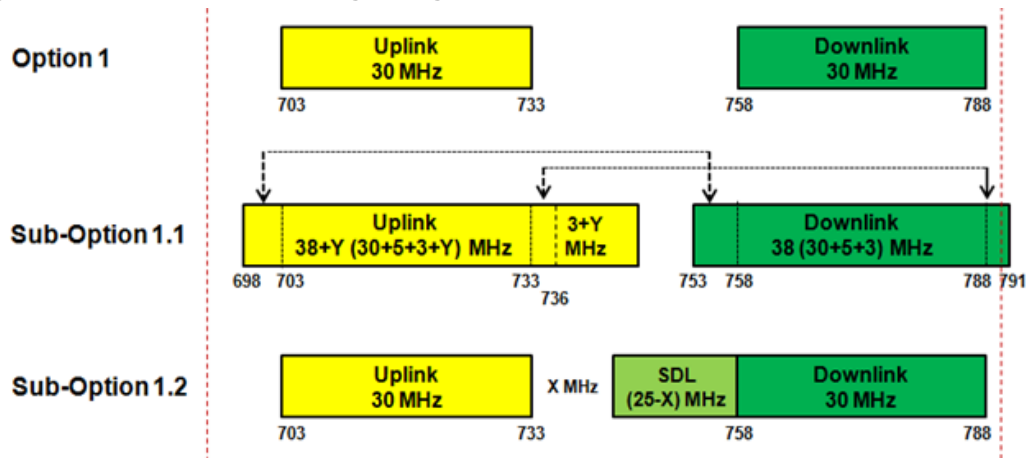

Source: CEPT draft brief on agenda, January 2014

And above 1 GHz

Additional spectrum options above 1 GHz ranging from 1.4 GHz (Mainland China) to 5 GHz are considered for local communications and temporary use. It is less problematic and in demand than spectrum below 1 GHz.

It is certain that this type of spectrum would generate high migration costs for the railways.

ITU WRC-15: what is at stake?

From 2003 till date, ITU has been working continuously on preparing reports and recommendations on PPDR. The focus in 2003 was to identify bands for mission-critical voice and data for PPDR agencies. Broadband applications, particularly video, were thought to be relevant only for hot-spot coverage.

- Resolution 647 (WRC-2007) defined spectrum management guidelines for emergency and disaster relief radiocommunications.
- ITU-R Recommendation M.1826 (2007) worked on a harmonised frequency channel plan for broadband PPDR operations at 4940-4990 MHz in Regions 2 and 3.
- Resolution 648 (WRC-12) invited administrations to contribute to studies to support broadband PPDR. It is currently one of the foremost tasks of LEWP/RCEG and CCBG in cooperation with ETSI TC TETRA WG4 'TETRA High Speed Data' to provide sustained operational and user requirements for 2 x 10 MHz of dedicated frequency spectrum below 1 GHz.

The forthcoming WRC in 2015 (WRC-15) will review and revise existing radio regulations for harmonised PPDR frequency spectrum. Recommendations ITU-R-M.2015 will deal with frequency arrangements for PPDR systems in UHF bands in accordance with Resolution 646 (WRC-03). ITU-R-M.2009 will work on radio interface standards for use by PPDR operations in some parts of the UHF band in accordance with Resolution 646 (WRC-03).

Depending on this, WRC-15 might revise Resolution 646 (Rev. WRC-12) in order to identify globally or regionally harmonised frequency bands for PPDR mission-critical broadband mobile communications.

Options for future PPDR networks

Spectrum issues are at the heart of future security networks. A few options can be studied regarding future security networks:

- Use of dedicated spectrum. This section deals with future dedicated spectrum for broadband PPDR services.
This spectrum is for exclusive use by PPDR services.
- Use of carrier commercial networks to provide PPDR
- An additional approach is a hybrid model utilising both a dedicated PPDR and commercial network
- Shared spectrum

This spectrum represents an additional portion of spectrum not exclusively assigned to PPDR services but shared with other services. This option can be achieved through specific regulatory framework such as Licensed Shared Access (LSA) and Authorized License Access (ASA).

Figure 13: Spectrum options

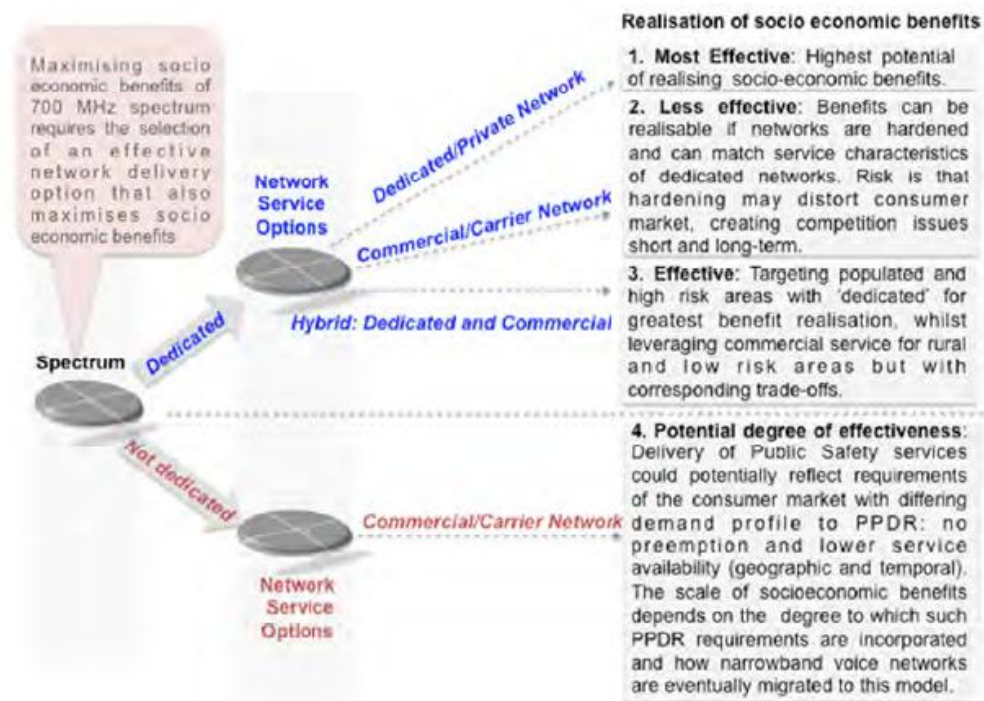

Source: TCCA

A number of dedicated spectrum bands are considered for broadband PPDR worldwide.

- The 700 MHz band, primarily used for TV broadcasting, is gaining momentum in Asia, Latin America, Middle East and Africa. In the USA, a total of 10+10 MHz spectrum in the 700 MHz band has been already allocated to broadband PPDR services (FirstNet). In Europe, the 700 MHz is a candidate band alongside the 400 MHz. This spectrum is not expected to be allocated before 2015.
- The 400 MHz is also a candidate in Europe. Until now, it has been widely used by two-way radio.
- Additional spectrum above 1 GHz is also being considered. The 2, 3 and 4 GHz bands are candidates. Basically, broadband PPDR requirements above 1 GHz are understood to be for temporary use only. In Europe, the 4 (4940-4990 MHz) and 5 GHz (5150-5250 MHz) are recommended. In Asia-Pacific and the USA, the 4 GHz is also envisaged.

- Outside these bands, some countries are considering specific bands: Australia has identified 2 x 5 MHz for broadband public safety in the 800 MHz LMR band and China is planning to use TDD LTE for broadband public safety in 1.4 GHz.

The frequency spectrum had been already reserved for construction of LTE networks in the public safety segment in some countries, principally USA, Canada, Australia and UAE.

A multi-band approach will probably be implemented. ACMA in Australia is promoting this kind of approach:

- Wide-area narrowband voice and data using land-mobile network topology, predominantly using the 400 MHz band
- Wide-area broadband data using cellular network topology, potentially using the 800 MHz band and supplemented from commercial services
- Short-range, high-capacity data deployed within high-demand hotspots, using the 4.9 GHz band.

Figure 14: The multi-band approach by ACMA

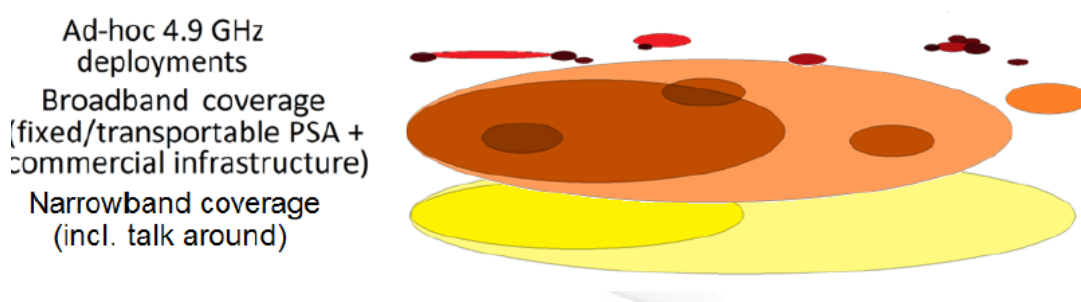

Source: ACMA, a multi-band networked approach to public safety communications

Figure 15: The multi-band approach by ACMA: example applications

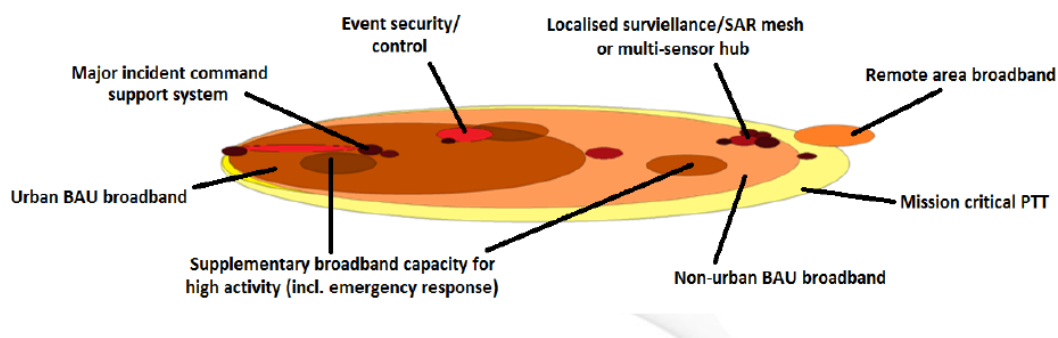

Source: ACMA, a multi-band networked approach to public safety communications

Shared use of spectrum

Spectrum band sharing is a key tool applied in spectrum management. It allows the coexistence of different technologies and radio communication services in the same band and in the same timeframe and enables the accommodation of new requirements.

In Europe and throughout the world, band sharing is not unusual. As shared technology improves, it seems possible to open PPDR spectrum to commercial use. Licensed Shared Access (LSA) or Authorized Shared Access (ASA), Dynamic Frequency Selection (DFS), Cognitive Radio (CR) and Software Defined Radio (SDR) are among the means of sharing spectrum.

Temporary Licensed Access

Temporary Licensed Access (TLA) to some shared bands aligned to the Licensed Shared Access (LSA) or Authorised Shared Access (ASA) models. They have been identified by the RSPG and the CEPT as one of the key tools to overcome the European spectrum challenge. The main feature is to enable dynamic use of shared spectrum with predictable QoS. Sharing agreements between incumbent spectrum users and prospective ASA licensees may foresee various arrangements. In particular, there may be: frequency-sharing, when the incumbent user only uses a subset of the available frequencies; time-sharing, when the incumbent user does not require using spectrum continuously over time; and geographic-sharing, when the incumbent uses only a geographically-limited portion of spectrum.

The ASA concept is rapidly gaining currency in a number of international fora. In the USA, in December 2012, the FCC adopted a Notice of Proposed Rulemaking on the 3.5 GHz band, which considers the implications of a version of the ASA concept alongside small cells deployment in the 3.5 GHz band.

According to Antonio Nicita and Maria Alessandra Rossi⁸, "ASA may also stimulate service innovation, especially as regards e-health, e-education and other public e-services. This may be a by-product of agreements between prospective ASA licensees and incumbent non-commercial users. For instance, in the 380-470 MHz band, currently used by the Ministries of Home Affairs or Interior to provide PPDR/PMR/PAMR communications, there is scope for ASA agreements that may provide for non-monetary compensations in the form of innovative broadband PPDR services in exchange for sharing of the spectrum assignment."

Figure 16: The LSA concept

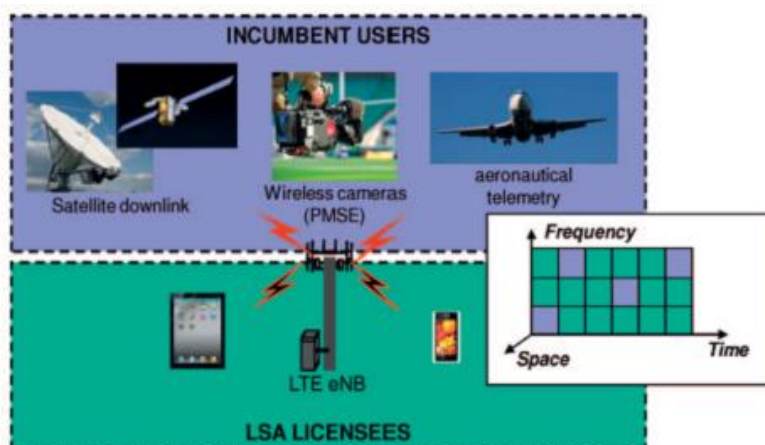

Source: Huawei

LSA/ASA presents the following advantages and drawbacks:

Table 6: Advantages and risks for LSA

Advantages	Risks/constraints
Allows more efficient use of spectrum: no change for the incumbent user of the spectrum and provides opportunities for new users/applications.	Need for reliable sharing agreements between primary spectrum users and LSA licensees.
New spectrum can be made available almost on a pan-European basis.	A robust authorisation system must be built and has to be 100% reliable: it could be based upon a data base model in order to provide permanent updates on spectrum availability.
Gives confidence to NRAs and spectrum managers as all LSA users are licenced.	Need to manage the authorisation system.
Compared with the licenced-exempt	Subject to negotiation with the incumbent

⁸ In a paper released in Communications & Strategies #90, H2 2013.

Advantages	Risks/constraints
scheme, it provides more predictable user. conditions of use and almost allows them to provide the same quality of service as if primary users of the spectrum.	

Source: IDATE

Various sharing options are possible with ASA:

Figure 17: ASA Spectrum sharing options

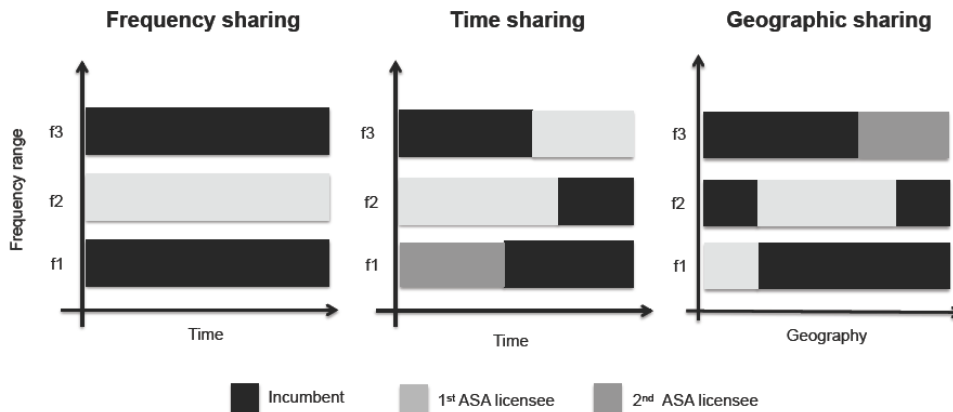

Source: Communications & Strategies, No. 90, H2 2013

Dynamic Frequency Selection (DFS)

Dynamic Frequency Selection (DFS) represents a form of spectrum sharing with radars. At some level, DFS has been successful; however, it must also be noted that changes over time in the characteristics of the radar systems necessitated changes in the means of detecting (and avoiding) them, and that these changes were not easy to distribute to end-user equipment.

Cognitive Radio (CR) and Software Defined Radio (SDR)

Cognitive Radio and Software Defined Radio (SDR), which can ensure that end-user equipment can be upgraded over the air link, is already used in the cellular and defence sectors, for example, in the USA. It is an ultimate interoperability and cost-effective solution.

SDR technology still has to prove its capability to support software evolution and certification. No large-scale deployment has been made yet and it will take some years before the technical issues associated with this new technology are solved. It is likely that the cost of handset will be higher than the one of commercial terminals but no precise figure can be given today.

Railways spectrum - 900 MHz GSM-R band

GSM-R which operates in the 900 MHz band (876–880 MHz uplink and 921–925 MHz downlink), enjoys access to a sub-1 GHz frequency band which has favorable propagation characteristics but does not enable use of 5 MHz channels (used in 3G and in LTE). An extension of this band is being discussed in Europe and has already been allocated to the railways in Germany with additional channels in the 873–876 MHz and 918–921 MHz range.

- The E-GSM-R band is used is an ISM band in the USA (used by RFID). There is some pressure in Europe for the re-allocation of this band to unlicensed use.
- It should be noted that CEPT recently allocated the 870-875.6 MHz band to unlicensed wireless M2M systems.

According to inputs from ECO and given the pressure from other users, it seems necessary for the railways sector to be more active in protecting spectrum assets.

Conclusions

Harmonised spectrum would facilitate interoperable operations but it is very unlikely that this will be the case in Europe. This will clearly impact the terminals but recent development in chipset enable the support of close to 40 different frequency bands.

The most interesting frequency bands for railways are under 1 GHz as the existing GSM-R masts could be re-used. The 700 MHz band is the first candidate as it will become available throughout Europe in the 2016-2020 timeframe and that specific public safety allocations could be defined.

If the GSM-R was feed up by railways, we can evaluate the value of this spectrum taking into account the recent auctions for sub-1 GHz spectrum in Europe. The 800 MHz band provides the best benchmark values: we observed t spectrum auctions prices ranging between 14 to 49 euro cents per inhabitant per MHz (14 for Sweden and 49 for Germany).

As far as SDR is concerned, the technology still has to prove its capability to support software evolution and certification. No large-scale deployment has been made yet and it will take some years before the technical issues associated with this new technology are solved. Migration from GSM-R to LTE will be possible with multimode/multiband handsets for which the additional cost is not expected to be very important.

5.2. Using MNO technology without rail-specific adaptations

LTE is seen as a very serious option for use by the railways, as LTE upgrades (releases 12, 13, 14) will be designed to meet PPDR requirements. However, it still needs to be assessed if LTE can provide the required level of requirements for critical communications.

It was also mentioned by many stakeholders during the interviews that there is a strong need for roaming on public networks.

5.2.1. Implications of supporting MNO networks with minimal modification

There are very significant synergies between MNO capability and railway requirements:

- Coverage remains an important issue, especially along railtracks;
- Roaming agreements are mandatory (for border-crossing operations);
- Services however exist already (SBB in Switzerland).

Site reuse or sharing can be very beneficial but needs to be further assessed.

Coverage, reliability and robustness are basic requirements for the railways. The cost of the communications networks is of course of major importance but the ability to manage/oversight it is also very important.

There is a need for specialised services (e.g. broadcast voice calls, group voice calls, multi-party voice calls, and support for functional addressing by train, engine or coach number or functional number) and ETCS. Prioritisation by the network is also needed, especially when the network is under stress (multi-level priority and pre-emption are needed).

In the future communications system, there will be a need for re-architecting services such that current network functions are dealt with at application level. This will provide a “future-proof” solution as the applications will not be any more dependent upon the radio network used by the railways.

5.2.2. LTE & LTE Advanced

Today, LTE networks are being deployed rapidly in Europe. LTE provides much greater bandwidth but the railways do not appear to need it for present applications.

LTE Advanced features

LTE-Advanced is often boiled down, unjustly, to being about carrier aggregation (CA). This feature comes with LTE Release 10 and improves both capacity and throughputs for the user and, more importantly, brings more flexibility to mobile network operators to manage their spectrum efficiently.

The feature was first launched in South Korea in June 2013 by SK Telecom, followed by the two other carriers, and making from the country one of the most advanced countries on the LTE market. By aggregating 2x10 MHz, the carriers provide Cat 4 throughputs with peak data rates of 150 Mbps in the downlink, something that can be reached when using 20 MHz of contiguous spectrum but which does not rely on carrier aggregation. CA will enable operators to provide the same quality of service in areas where they do not have the same amount of spectrum available.

Although commercial deployments are still limited outside South Korea for the moment, many operators are trialling CA all over the world and 2014 should see major launches all over the world. After Cat 4, carriers should also trial or launch services based on the aggregation of 2x20 MHz of spectrum (instead of 2x10) to provide Cat 6 throughput with data peaks of 300 Mbps in the downlink. MegaFon in Russia was the first carrier to launch such services in limited parts of Moscow in February 2014. SK Telecom should be the first to make it available on a large scale in 2014.

LTE-Advanced innovations - LTE-Advanced is ways richer than just carrier aggregation

It is commonly recognised that LTE-Advanced starts with the Release 10 of LTE and onwards. However, there is a series of terms of LTE-A, LTE-B and LTE-C which is sometimes used to refer to different evolutions within LTE-Advanced. For those players who use these variations, LTE-A refers then to LTE Release 10 and 11, while LTE-B refers to LTE Release 12 and 13 and LTE-C refers to LTE Release 14 and 16 and so on...

As we have seen previously, carrier aggregation is just one of the many features that come with LTE-Advanced with LTE Release 10 and onward. Specific features included in a given 3GPP Release are aimed at being enhanced in further Releases. This is the case, for example of, carrier aggregation. Release 12 for instance brings the possibility to aggregate FDD and TDD carriers, while Release 13 will probably bring the capability of aggregating TDD component carriers in different bands, something currently only possible with FDD mode.

At present, Release 12 is the latest Release under development within 3GPP and should be finalised by the end of 2014. Release 13, the next Release, due to initiate 'LTE-B' developments is in the early stage of standardisation and should not be frozen in its specifications before the end of 2015.

The main features that are, or will be, part of LTE-Advanced are summarised in the following table:

Table 7: New technologies and associated benefits in LTE-Advanced

Feature	Benefits	Challenges
Carrier aggregation	Higher data rate (Cat 4 UE up to 150 Mbps, Cat 6 UE peak 300 Mbps DL & 50 Mbps UL), improved data capacity	LTE spectrum fragmentation generates a huge number of bands combination
HetNets	Expand networks capacity, limitation of interference between the macrocell layer and the small cells layer	Management of interference, especially with cells of different coverage, power
eICIC	Improved data rate at the cell-edge	Coordination between the different cell layers
CoMP	Throughput fairness across coverage area, expected gain at cell edge: 15% - 30%	Time synchronisation and low latency is required between involved sites
Higher Order MIMO	Higher data rate and spectrum efficiency	Practical issues that need to be resolved (physical space on a mobile handset)

Feature	Benefits	Challenges
Relay function	Extends coverage in cases where wire backhaul is difficult or uneconomical to use	Performance must be kept for normal macro users. Duplexing may also be required when operating in shared spectrum
Device-to-device	Enables two devices to discover themselves directly and communicate with or without the need for a network	Interference mitigation between cellular network and the communication between the two devices.

Source: IDATE

LTE-Advanced European market taking off in 2014

On the market side, deployments of LTE-Advanced can be expected to really get underway on a massive scale in 2014. We believe that LTE-Advanced services will enable more tiered pricing with higher differentiation based on throughput, data volumes and the number of devices that will enjoy these services. Some operators may choose to include LTE-Advanced for certain data plans without changing tariffs while others will propose it as an option to existing data plans.

Table 8: LTE-Advanced deployment and features

Timescale	Deployments	Features
2010-2012	Early trials	5 or 10 MHz radio channels (150 Mbps)
2H 2013	First commercial launches	Higher capacity/throughput and/or efficiency (300 Mbps)
2014-2016	Massive commercial launches	Greater capabilities (450 Mbps)

Source: IDATE

Critical communication applications

Within 3GPP, a new working group SA6 was set up for the development of critical communication applications in the LTE standard. The group is working on specific critical communications requirements such as PTT (Push-To-Talk) or proSE for the direct mode.

Release 12 & 13 of the LTE standard will contain such specific developments. Release 12 is due for Q1 2015. The completion of current work item in Release 13 will be 18 months to 2 years after release 13, so it means Q1 2017 for the availability of all critical communication features.

Conclusions on the use of LTE/LTE-Advanced

Even though the use of LTE for very high speed is still under study, equipment manufacturers claim that it will be possible in the future if light modifications to the standard are made by the 3GPP. This is the only limitation today to the use of the LTE/LTE-A technology by railways: LTE/LTE-A is able to provide the necessary capacity, data rate and latency needed by railways. The most important question is the frequency band used and this question was analysed in the previous section of this report.

5.2.3. 5G already on the radar - Does European rail need 5G data rates?

Although the notion of '5G' is still hard to define and remains a vague concept, a degree of consensus seems to be emerging on the direction that the technology should take and towards which horizon. The date 2020 is often mentioned as its estimated time of arrival. Correspondingly, the talk of the technology is often that it should rather be an evolution in various fields rather than a complete revolution. The mention of 2020 as an horizon for 5G, however, serves to split the scenarios for actual network deployment: some players see the early availability of infrastructure and devices for 5G starting at that point, whilst others only see equipment development starting in 2020 and the first deployment and commercial launches around 2022 to 2025.

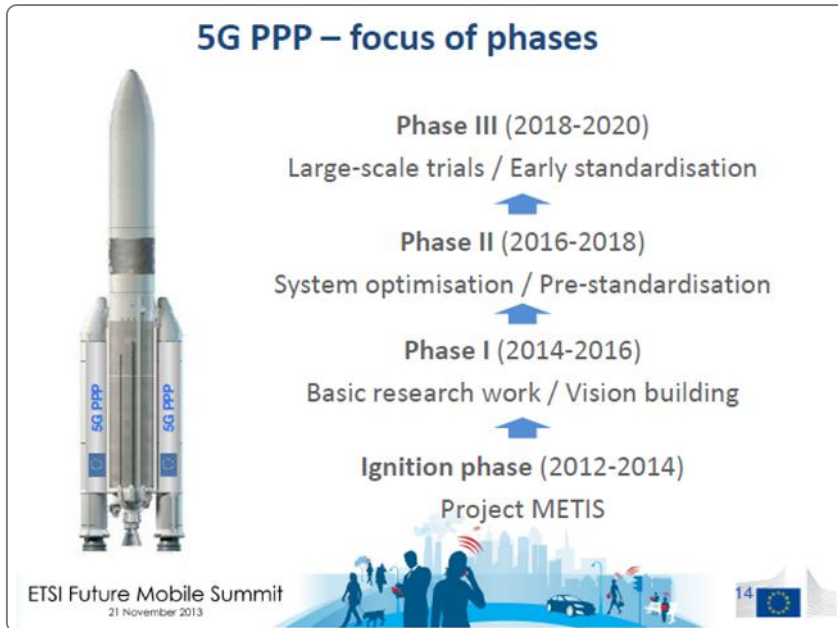
Figure 18: Possible timeline for 5G development

Source: ETSI

Whatever the divergence of opinions on the timeline, some general ideas are starting to appear inside the industry to describe 5G:

- 5G will have to be suited to a whole raft of services, ranging from consumer services to any vertical market in the industry, going through public safety organisations. Whereas 4G was rather conceived purely as a mobile broadband technology, 5G will have to be flexible enough to allow new services or business models to emerge.
- 5G will thus have to function on any kind of spectrum, be it low or very high, be it shared, licensed or unlicensed. It will need to collaborate more easily with other technologies (terrestrial or not), perform perfectly in both densely-populated and rural areas, and operate in traditional cellular mode as well as in new mode, such as in mesh/relay mode when necessary
- 5G will also have, of course, to be more spectrally efficient but also more energy efficient to allow new use cases, new devices or objects to emerge and communicate with the resources available. Together with energy efficiency, cost efficiency will play an important role in 5G

In terms of concrete specifications, METIS, the EU-funded organisation, defines 5G as a technology to support mobile data volumes 1,000 times higher per area; numbers of connected devices 10 to 100 times higher; typical user data rates 10 times to 100 times higher; battery life 10 times longer for low power MMC; and end-to-end latency five times lower.

5G spectrum will be a combination of existing licensed spectrum (2G, 3G and 4G), unlicensed spectrum and new frequency bands above 6 GHz. Unlicensed bands such as the 2.4 GHz and the 5 GHz bands currently used by Wifi systems are likely to be used by 4G and 5G networks in the future. 5G systems will re-use the frequency bands of 2G, 3G and 4G radio networks which sit below 5 GHz.

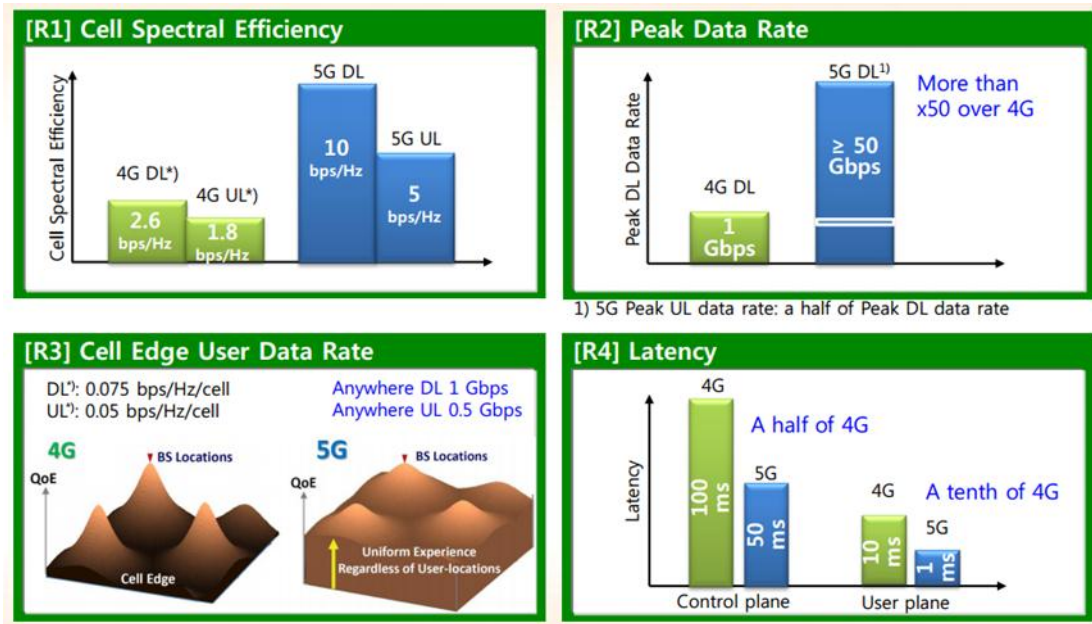
Figure 19: 5G objective for the 5G Forum

Source: 5G Forum (Korea)

5.2.4. Possible use of hardened commercial networks

99.9% would be a realistic figure for a really hardened network (99.999% is seen as completely unrealistic for commercial networks).

Cost implications

Today, it is difficult to quantify the exact cost savings made by the use of hardened public networks, as there are not any such systems in operation.

5.2.5. Hybrid models

Hybrid models would be based upon consider several IP-based bearers. Various technologies such as GSM-R (GPRS/EDGE), WIFI, LTE, satellite could be combined.

Satellite networks

Satellite can be useful to bring connectivity in very remote areas where there are no other communications systems available. Satellite will be good enough for certain railway lines.

For many railways stakeholders, MEO (Medium Earth Orbit) satellite could be part of a hybrid solution. Satellite is considered as “better than nothing” for some rural areas.

The cost of hybrid terminals supporting satellite access would probably be in the 100-200 K€ range and potential limitations are likely in terms of availability of bandwidth.

Satellite communications might not be able to support all functionalities required by railways (latency is probably too important for some applications) but it could provide a good backup solution for low traffic railways.

Wifi networks

Different technologies (from 802.11b to 802.11ac)

WiFi, as standardised by IEEE, uses unlicensed frequency bands in the 2.4 and 5 GHz frequency bands. The latest technical improvements involve wider bandwidth and the use of

MIMO to boost data rates. The various WiFi generations and their respective characteristics are presented in Table 9: WiFi generations below.

Table 9: WiFi generations

WiFi generation	Release date	Frequency band	Bandwidth	Maximum theoretical data rate	MIMO	Outdoor range
802.11a	1999	5 GHz	20 MHz	54 Mbit/s	No support	~110 m (5 GHz)
802.11b	1999	2.4 GHz	22 MHz	11 Mbit/s	No support	~130 m
802.11g	2003	2.4 GHz	22 MHz	54 Mbit/s	No support	~130 m
802.11n	2009	2.4 and 5 GHz	20 MHz, 40 MHz	Up to 600 Mbit/s (in 4x4 MIMO and 40 MHz bandwidth configuration)	Up to 4 x 4	~240 m
802.11ac	2012	5 GHz	20, 40, 80 or 160 MHz	Up to 6.77 Gbit/s (in 8 x 8 MIMO and 160 MHz bandwidth configuration)	Up to 8 x 8	n/a

Source: IDATE

802.11ac is now being implemented in a variety of devices including smartphones and tablets. The 60 GHz band will be used by the 802.11ad version of WiFi and will allow very high data rates for short-range communications.

Because WiFi is an unlicensed technology available in nearly all mobile devices it has enabled the development of a very wide network and user equipment ecosystem. The direct impact of this is more affordable infrastructure and thus reduced CAPEX as shown in Figure 20.

Figure 20: Cost advantage of WiFi deployment in small cell environment

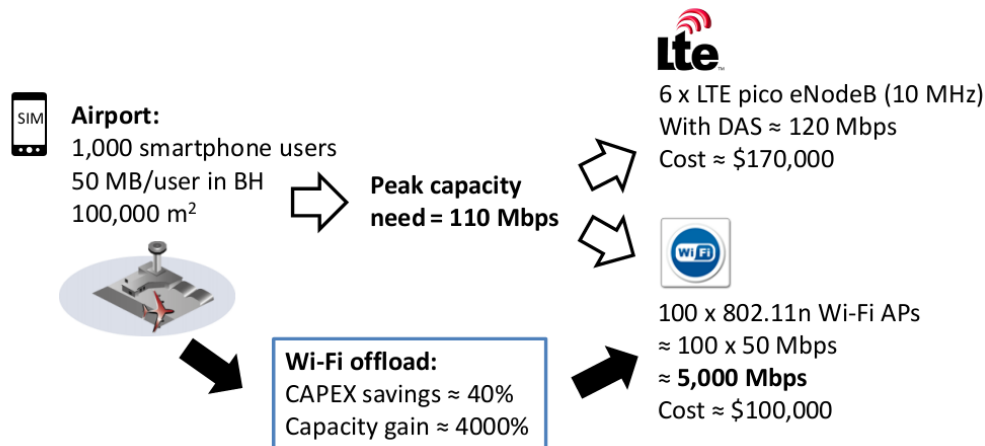

Source: Hetting Consulting

5.3. Integration with PPDR

The PPDR industry is currently focusing on spectrum harmonisation. There are two separate families of technology for providing PPDR over 2G or 3G wide-area wireless communications: dedicated PPDR systems and commercial cellular networks:

- The use of commercial mobile networks for non-mission critical PPDR services and applications needs to be carefully reviewed but is not by definition problematic.

- To be usable for mission-critical communication, though, mobile radio communication systems must fulfil four key requirements. It is also worth considering the best use of spectrum.

The roadmap of current NB/WB PPDR networks is likely to be consistent with the railways roadmap as the former are in place at least until 2025/2030.

5.3.1. GSM-R and critical communications in other sectors

More than twenty years ago, GSM was chosen by the UIC as the radio technology for a pan-European mobile railway network. This choice was reaffirmed in 1995, and led to the first deployments in the years 2000. At that time, the idea was to rely on a standardized technology, while bringing unique features that commercial technologies did not offer. Historically, national railways had indeed been relying on often country-specific and proprietary technologies with little to no competition on the equipment market and more importantly no interoperability between existing systems.

Technologically speaking, it differs very little from GSM and has additional features similar to technologies used by PPDR forces. Those specific features are mainly advanced speech call capabilities such as voice call group services; voice broadcast service, emergency calls or specific numbering features. Users can for instance be reached according to their functions rather than by their number. It is supplemented by data services used for communication with the European Train Control System (ECTS). It is devised as to enable guaranteed performance at speeds up to 500 Km/h.

While GSM-R has since then proven its reliability and usefulness in the day to day operation of railways in Europe and worldwide, the increasing reliance on data to improve security of trains and passengers and manage traffic effectively raises the question of the technological and economical evolution of GSM-R. Latest technology developed within the 3GPP may indeed provide high throughput, which benefits consumers on a day to day basis; however, these benefits of improved technology are limited or lost with GSM-R to GPRS/EDGE. Behind the question of the technology is also raised the question of the ownership of such network. While some critical features are currently not supported by deployed LTE networks (although work is under way in Release 12 and onwards), the question is raised of whether railways companies could rely on commercial cellular networks with specific features. In the context of critical operations such as operating trains, the scenario would seem challenging (after all, what could match the reliability of a dedicated technology with dedicated spectrum?), but the question is also raised in other sectors. Blue light forces for instance see a clear interest in many broadband applications in their daily work, but are not able to use them because of technology limitations.

This scenario is probably extreme, but paves the ways for further reflections on intermediary situations where specific networks for specific users could be operated differently and so could be providing specific services such as QoE, voice group calling, instant emergency signaling. While usage and requirements vary from one sector to another, challenges converge, at a time where new technologies enable new innovating applications. How to leverage on such capacity and latest technology developments while enabling secure, 7 days a week, 24 hours a day operational networks?

In other sectors, examples exist of PPDR networks operated by a third party and acting as a MVNO to provide mobile broadband services. This is the case in Belgium for instance where the national emergency network is partly run as a MVNO, providing a TETRA network to the PPDR forces while offering 3G data with preferential access and services through agreements with all Belgian mobile network operators. Other examples exist in the UK (Airwave) or in Finland where VIRVE network operates a TETRA networks as an MVNO to Finland's authority. This example is interesting because the Finnish railway is studying the possible use of VIRVE instead of GSM-R.

WIK and IDATE were key contributors to the 2012 prototype Spectrum Inventory project for the European Commission, and are familiar with usage of essentially all applications in the 400 MHz to 6 GHz bands.

The following table highlights the variety of existing technologies and their possible evolution:

Table 10: Existing and future radio technologies for railways and other sectors

Sector	Usage	Requirements	Mobile technology	Mobile data	Expected evolution	Comments
Railways	Critical operations and business supporting communication (voice & Data)	Resilience, coverage	Previous analog technologies (UIC 751-3 ...) GSM-R,	GPRS and Edge on some terminals	To be defined	
Civil aviation	In the cockpit: radio navigation, communication, surveillance Real time traffic and flight status data transmission, meteorological services In the cabin: voice and data	Immunity to interference, reliability	In the cockpit: VHF radio (voice), ACARS, VDL2, VDL3, Inmarsat... In the cabin: Air ground system Satellite	ACARS: 2.4 Kbps VDL2: 31.2 Kbps Current Air to ground system: 400kbps / user Satellite: around 2-4 Mbps / user	LTE for air to ground system	Air to Ground systems are mostly deployed in North America but trials have been carried out in Europe (T-Mobile, Alcatel Lucent and Airbus)
Maritime traffic	Automatic identification systems, maritime safety information, meteorological services	Ship to ship, ship to shore communication, maritime safety information, emergency alerts	Two way Satellite communication VHF, Digital Selective Calling			
Cars: eCall (Europe), ERA-Glonass (Russia)	Emergency, traffic management	in band modem capability	GSM / UMTS	Yes, in band modem	LTE	With All-IP technology such as LTE, several options are available. IMS can be used, CSFB if Circuit switch is also supported, in-band modem over VoIP
Cars: entertainment	Traffic condition, navigation, POI, streaming,	Throughputs	3G/LTE	Depending on the baseband and bandwidth	LTE, LTE-A and further releases	
Blue light	Group voice communication, Priority calls, live operational video streaming, data transfer (e.g patient record), Point to point communication (without supervision of a network)	Effective and reliable communication, interoperability, mission critical coverage, security (encryption)	Previously (VHF, UHF, ICCS), TETRA and to a lesser extent TETRAPOL	Up to 115.2 kbps in 25 KHz channel or up to 691 Kbps in 150 KHz channel	Hybrid system of TETRA systems with 3G LTE for data transfer as long as requested PPDR functions are not available	Commercial networks are already used by some agencies in the UK for instance
Other utilities	Group voice communication, live operational video streaming,		TETRA, to a lesser extent TETRAPOL, GSM/3G/4G	Depending on the baseband and bandwidth	LTE, LTE-A and further releases	Importance of 3GPP works on Device to Device, Relay,

Sector	Usage	Requirements	Mobile technology	Mobile data	Expected evolution	Comments
	data transfer, Push to Talk					proximity services starting with LTE Rel 12-13

PPDR service requirements could fit with railway requirements:

- Coverage needs to be improved;
- Blue light roaming agreements enable smooth border communications;
- There remains uncertainties on future spectrum allocations;
- Blue Light Mobile: first MVNO of a PPDR player, using 3G (LTE in the coming years):
 - Very high QoS for critical customers;
 - Main challenge remains during emergency situations when commercial networks are congested.
- Broadband on TETRA might not be as resilient as voice
- Towards hybridization TETRA (for voice) and LTE (for Broadband): this could provide a combination of the two best worlds.

5.3.2. More stringent requirements for mission-critical services

Mission-critical traffic is likely to be subject to more stringent requirements in regard to security, coverage, reliability, and robustness.

- The infrastructure must be resilient, redundant and highly available mostly through redundant network architecture and protected network elements.
- Communication must be reliable, accessible and stable.
- Secure communication with functions protecting users from jamming, interception and spoofing:
 - mutual authentication of infrastructure and terminals;
 - methods for temporarily and permanently disabling terminals and smart cards;
 - functions to detect and compensate for jamming at the air interface;
 - air interface encryption of user data and signalling data including addresses;
 - end-to-end encryption of voice and data communication.
- Point-to-multipoint communication must be supported (group calls).

Demand is growing from PPDR organisations for higher data transmission speeds and lower latency, for, for example, video transfers and remote access to data bases and applications. The architecture of PPDR networks will likely evolve in the same direction as the architecture of commercial mobile networks.

5.3.3. PPDR over 2/3G

With the Push-To-Talk Over Cellular (PoC) service based on 2.5G and 3G technologies, it is possible to create or access talk groups and set up group calls within them by pressing a PTT key in the handset. Motorola released its fully-integrated PTT solution based on its iDEN trunking system as early as 1995. In 1996, Nextel bought the iDEN trunking system, and closed it mid-2013.

PoC service is suitable for PPDR services to a certain extent. Technically, they are implemented in the GPRS or CDMA packet core networks by using VoIP technology and, typically, the SIP and RTP of the IETF to relay voice packets from one source to multiple recipients.

The following key features of TETRA would not likely be provided in PoC networks, either due to lack of technical supporting capabilities or being poor match with the mainstream business objectives.

- DMO
- Call authorised by dispatcher
- Area selection
- Access priority
- Pre-emptive priority call
- Discreet listening
- Ambience listening

Figure 21: Coverage and data rates of wireless network technologies

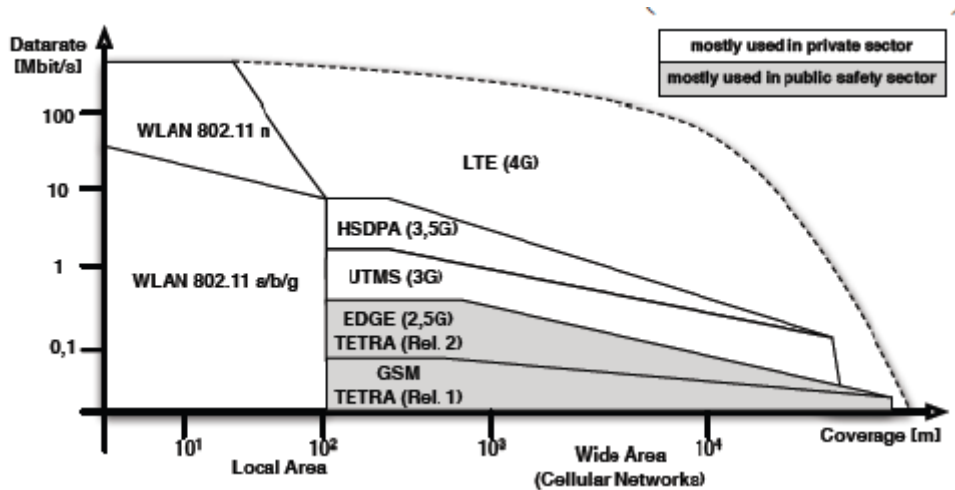

Source: The MOBI project: Common Mobile Digital Services for all PPDR Vehicles, January 2014

The provision of services for railways over LTE networks would certainly bring much higher capacity and data rates but wider channels would have to be made available: GSM uses 200 KHz channels whereas LTE can use 1.4, 3, 5, 10, 15 and 20 MHz channel bandwidth.

5.3.4. PPDR over LTE

The provision of PPDR services through commercial mobile networks is predicated on future LTE 700 MHz systems. Early leadership here came from the US Firstnet LTE-based network and its funding.

The US National Public Safety Telecommunications Council (NPSTC), TCCA, ETSI Technical Committee, TETRA and others all back LTE, there is now a clear global consensus that LTE will be the baseline technology for next generation broadband public safety networks.

However, introducing brand-new LTE technologies for PPDR is expected to complement, not replace existing PMR networks, which will continue as standards for PPDR voice service for at least ten years.

Table 11: LTE bands

LTE Band Number	Uplink (MHz)	Downlink (MHz)	Main regions of use
1	1920-1980	2100-2170	Asia, Europe
2	1850-1910	1930-1990	Americas, Asia
3	1710-1785	1805-1880	Americas
4	1710-1755	2100-2155	Americas
5	824-849	869-894	Americas
6	830-840	875-885	Japan
7	2500-2570	2620-2690	Asia, Europe
8	880-915	925-960	Asia, Europe

LTE Band	Uplink	Downlink	Main regions of use
9	1749.9-1784.9	1844.9-1879.9	Japan
10	1710-1770	2110-2170	Americas
11	1427.9-1452.9	1475.9-1500.9	Japan
12	698-716	728-746	USA
13	777-787	746-756	USA
14	788-798	758-768	USA
17	704-716	734-746	USA
18	815-830	860-875	Japan
19	830-845	875-890	Japan
20	832-862	791-821	Europe
21	1447.9-1462.9	1495.5-1510.9	Japan
22	3410-3500	3510-3600	

The 400 MHz spectrum is mainly used for public safety or government entities in Latin America. Brazil has already dedicated the 450 to 470 MHz band to a rural programme. Mexico has allocated the 380 to 400 MHz band to public safety

Source: IDATE

Towards all-IP networks

VoIP is now mature, with users perceiving its quality as similar to that of classical telephony. New codecs might even offer quality better than classical networks.

The evolution towards an all-IP network seems inevitable.

IP was originally designed for military fixed networks. There are thus sound reasons to assume that the protocol as such is suitable for mission-critical communication. Second, it provides procedures to prioritise handling of emergency calls and multimedia priority services, an end-to-end QoS framework and broadcast of alert messages. The equipment of a mission-critical network must meet higher standards in terms of reliability and security, and the resources have to be dedicated to the mission-critical services.

Separation of the services layer from the network IP layer

In an all-IP network, services are implemented in the higher protocol layers, above the network layer. The physical location of the servers becomes less important, because the network layer provides inexpensive transport to almost every location. Further, the network layer makes the services independent of the access technology used (fixed/mobile, WLAN, UMTS/HSPA, or LTE) and of the operator of the access network.

It is, however, recommended to use service layer equipment which is dedicated to PPDR organisations. This service layer could be an evolution of existing TETRA network elements.

5.3.5. Expected capabilities: PPDR over LTE-Advanced

Current networks do not offer group calls, nor direct mode capability (calls made without access to the infrastructure) or other PMR-style functionality. Even person-to-person Voice over LTE is not yet fully standardised. Indeed, LTE Releases 8 and 10 did not include much of the functionality highly required for PPDR networks. Work is ongoing in 3GPP.

The challenge is to produce enhancements to the LTE standard to support public safety applications.

LTE-Advanced

Most probably, commercial LTE manufacturers and operators will only be willing to implement mission-critical features in their equipment and to upgrade their networks to become mission critical if it is profitable for them. Commercial LTE manufacturers might not implement LTE security features although they are part of the LTE standard.

LTE-Advanced provides better performance to mobile carriers and represents an upgrade to LTE networks, with backward compatibility.

The major benefits of LTE-Advanced are also bringing higher capacity to LTE networks, enabling an increased number of simultaneously active subscribers:

- Peak data rate is increased: up to 3 Gbps downlink and 1.5 Gbps uplink;
- Spectral efficiency is higher: from a maximum of 16 bps/Hz in Release 8 to 30 bps/Hz in Release 10;
- Cell-edge performance will be improved and will be at least 2.40 bps/Hz/cell (for DL 2x2 MIMO) according to 3GPP.

Front-runners such as South Korea, Japan and the USA are launching or preparing commercial launch of LTE-A even before many other markets have started their initial LTE deployments.

Table 12: LTE-Advanced deployment and features

	Deployments	Features
2010-2012	Initial deployments	5 or 10 MHz radio channels
2013	First commercial launches SKT launched first end June 2013 LGU+ launched mid-July 2013	Higher capacity/throughput and/or efficiency
2014-2016	Massive commercial launches	Greater capabilities

Source: IDATE

Table 13: 3GPP LTE-Advanced freeze dates

Release	Indicative freeze date
Rel. 14/15	Timing likely to be influenced by the WRC-15, scheduled for September 2015.
Rel-13	March 2016 Start June 2014 (RAN) Completion expected in December 2015
Rel-12	Stage 1: Requirements freeze in June 2013 (postponed from March for public safety work) Stage 2: Architecture freeze in December 2013 Stage 3: Signalling freeze in June 2014 (RAN protocols: September 2014) Implementation scheduled for September 2015
Rel-11	Stage 1: September 2011 Stage 2: March 2012 Stage 3: September 2012
Rel-10	Stage 1: March 2010 Stage 2: September 2010 Stage 3: March 2011

Source: 3GPP

Technical features for LTE-based PPDR services

Current work on Release 12 of 3GPP LTE standards, set for freezing in mid-2014, will the use of LTE to LTE-Advanced within a broadband public safety network. It will include such features as direct mode, proximity services and group communications system enablers, resilience and voice.

Proximity-based services (ProSe)

ProSe identifies physically-close mobile phones and links them, with two main elements:

- Network-assisted discovery of users wishing to communicate who are in close physical proximity and the facilitation of direct communication between them with, or without, supervision from the network.

- Direct communication means a radio connection between user mobiles without transiting the network. This saves network resources and allows public safety communication outside network coverage.

Proximity services meet the need for communication among public safety users even beyond the network. In the commercial area, they can support new modes of social networking, convenient file transfer between devices belonging to the same user and targeted advertising. Commercially, 3GPP standards will ensure that use of licenced spectrum is controllable and billable by the network operator.

Figure 22: Proximity services examples

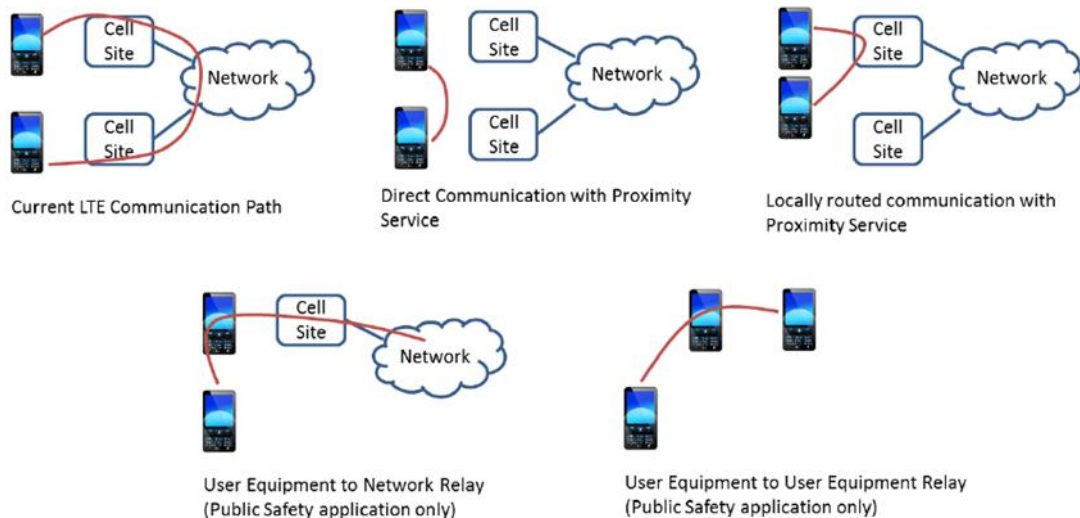

Source: 3GPP, July 2013

Direct Mode Operation (DMO)

DMO is an important means of communicating voice and narrowband data. It is used in in several ways:

- when there is no coverage (such as in buildings or tunnels), or when there is a risk of loss of terrestrial coverage, which is especially important for the police and fire organisations;
- to extend coverage by enabling a low-powered person-worn hand-portable terminal to communicate with a higher-powered vehicle-mounted terminal located within the coverage range of the terrestrial infrastructure;
- as extra capacity, in, for example, the terrestrial network (WAN), is congested;
- as a fall-back when the terrestrial network fails;
- for foreign units crossing the border.

The expectation is that 'BB data DMO' capability will also be needed to facilitate 'device-to-device' data communication.

3GPP is working on the inclusion of DMO into the LTE specifications Release 12.

Air-Ground-Air (AGA) communications

PPDR organisations may also have requirements for broadband airborne applications as used in the terrestrial PPDR network (Wide Area Networks, WAN). These typically involve a video stream being relayed from a camera mounted on a helicopter to a monitoring station on the ground. Ideally the airborne PPDR communication system should be compatible (i.e. within the tuning range) with the terrestrial BB networks (WAN).

Group Communication System Enablers for LTE /Direct Mode

PPDR users frequently need to communicate in dynamic groups that might involve both mobile users on the scene and fixed users ('dispatchers') working in a control centre. Often these groups operate in a PTT mode.

One aspect of group communication still being considered is how much functionality should be 'baked in' to the LTE infrastructure and how much should be delivered by non-standardised application servers. The use of application servers will allow different organisations or regions to customise the system operation to their own needs whereas 'baked in' solutions may be more efficient and simpler. It is expected that further discussion will take place on how to handle session management for public safety group communication and possible impacts on such technology as IP IMS.

Figure 23: Group calling

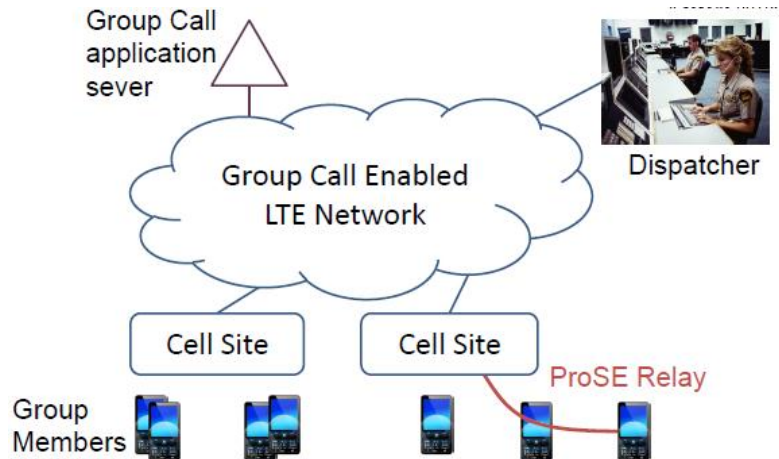

Source: 3GPP, July 2013

This functionality will be included in Release 12 of the standard although some functionality may be delayed until Release 13. This release is unlikely to be complete before 2015.

Other features or services

3GPP and ETSI are investigating what other elements can be added to meet PPDR requirements.

In addition to LTE, standardised technologies such as IMS and a number of service enablers specified by the Open Mobile Alliance (OMA) can also be leveraged for the realisation of IP-based multimedia services tailored to PPDR services. There are IMS-based solutions such as VoLTE and OMA PoC. In the longer run, the support of PMR-like services over LTE is crucial.

VoLTE

As an all-IP network, LTE does not support legacy services such as voice and SMS from scratch. For these reasons, technical solutions were implemented to still continue to propose those services on LTE devices, the idea mainly being to switch back to circuit mode on 2G/3G or to maintain two separate radios active in the case of CDMA-based networks – Simultaneous Voice and LTE (SVLTE).

In 2010, the VoLTE standard was adopted by the GSMA as the official solution to provide such services on LTE networks with a specific IP Multimedia Subsystem (IMS) profile. Later on, this profile was updated to include support for video calling and provision of other communication services.

The IMS is defined by 3GPP, and not only does it provide legacy voice services and SMS, but also value-added multimedia services, such as video sharing and status checks, during calls.

Even though early VoLTE services in South Korea have seen increasing ARPU, it remains to be seen whether the consumer will be willing to pay more for these services.

Critical network resilience and PTT

Another area of weakness in existing LTE is the capacity for 'graceful degradation of service' present in PMR networks. Indeed, it is always possible for the base station to be used to provide PTT voice services and voice broadcast services making use of the radio link in

PMR networks on a local basis. It is vital for critical communications systems to support continuous mission-critical network operations regardless of the existence of the backhaul link.

To address those scenarios, the EPC-less E-UTRAN Operation for Public Safety work is scheduled within the Release 13 of 3GPP LTE standards (2016). This work item will seek to address additional concerns about resilience of LTE networks and their suitability for public safety and other critical communications systems.

Prioritisation

Preferential treatment for access to and utilisation of a LTE network can be supported by the Multimedia Priority Service (MPS) specified by 3GPP. MPS is a subscription-based service that creates the ability to deliver and complete high-priority sessions in times of network congestion.

Other functionalities may include:

- Fast call set-up
- Emergency calling
- Group management and fleet management
- Late entry to a call already in progress
- Area selection (a group call based on the location of individual subscribers)
- Dynamic groups
- Encryption
- Enhanced broadcast
- High-power mobile
- Public safety-grade performance

5.3.6. International benchmark – PPDR networks

Today the nature of the business models in PPDR network operations varies slightly in Europe - there are some differences in the ownerships, in technical network operations and in network maintenance responsibilities.

Table 14: Ownership models – PPDR networks

Actor	Country	Name	Ownership	Main characteristics	Technical operation	Maintenance	MVNO services
Airwave solutions	UK	Airwave	Private company	Dedicated Network	Private company*	Private company	
Astrid	BEL	Astrid Blue Light	Government-owned company	Dedicated Network	Government-owned company	Government-owned company	✓
Virve	FI	Tuve	Government	Dedicated Network	Government-owned company	Private company	✓
Ministry of interior	FR	Antares	Government	Dedicated Network	Government	Government	
BDBOS	GER	BOSNet	Government	Dedicated network	Private company	Private company	

* the network is owned by a private company, there are strict restrictions set by the government concerning the ownership arrangements and the service level requirements; in these cases the network is dedicated only for the use of PSS organizations.

Astrid, Belgium

Astrid is owned and operated by a private company with the same name. The ASTRID company is owned by the Belgium Government. It was founded in 1998. The delivery of the TETRA network was awarded to a consortium (Kreutler / Nokia / Telindus) for the provision of a radio network. The service opened in 2003. The first level of maintenance is provided by Astrid, the other levels by the KNT consortium.

ASTRID network is built around TETRA with IP capabilities. It is made up of 500 base stations and supports around 56,000 subscribers in Belgium. Instead of choosing TEDS to add data capabilities to the existing network ASTRID decided to rely on wholesale roaming subscription on commercial cellular network, which boast good coverage, both indoor and outdoor.

To enable this, a MVNO was created, Bluelight Mobile. Bluelight has built its own core network. There is a specific SIM card, which gives ASTRID users the status of an international roamer, but with priority access. With such card, it is also possible to roam on neighbour networks. In the case of lost signal, the device automatically moves to another network.

Figure 24: Role of Astrid role as an integrator

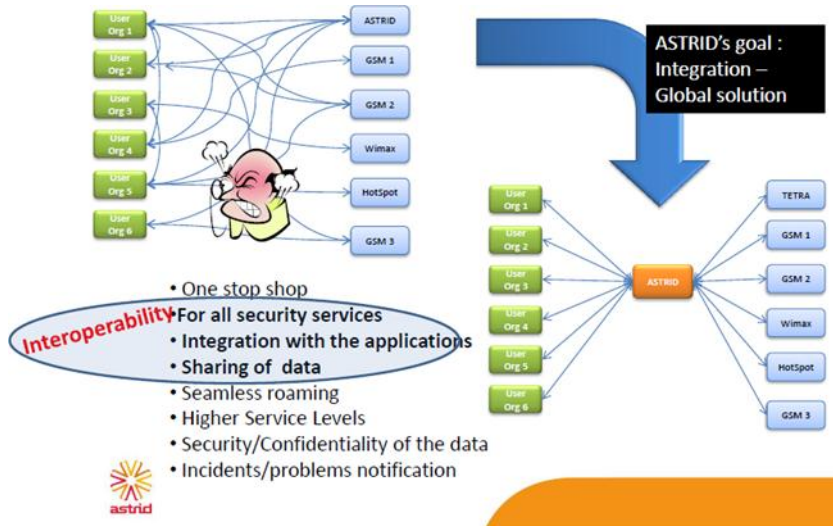

Source: Astrid, Daniël Haché, November 2013

Bluelight Mobile is a one stop shop solution. The SIM card provides an end-to-end encryption solution for secured communication. Utilities can subscribe to Bluelight Mobile. Bluelight Mobile is considered as a temporary solution but should here at least for 5-10 years.

Virve (Finland)

Founded in 1999, Virve started operation in 2002. It is the Finnish national TETRA network, and a limited company owned by the Government. With 1,300 base stations, it has had full geographical coverage since 2002. There are 32,000 users of Virve networks.

The network was delivered by Nokia and later updated by EADS Secure Networks (Cassidian). The network is owned and operated by Suomen Erillisverkot Oy, which is owned by the Finnish Government. Although it is a dedicated network, it initially used the telecom incumbent's network (Base stations and transmission links from Sonera) and was maintained by Sonera to lower up-front costs.

Virve also operates as a MVNO. Virve studies how its network could be used by Finnish Railways instead of GSM-R.

Figure 25: Virve users breakdown by sectors

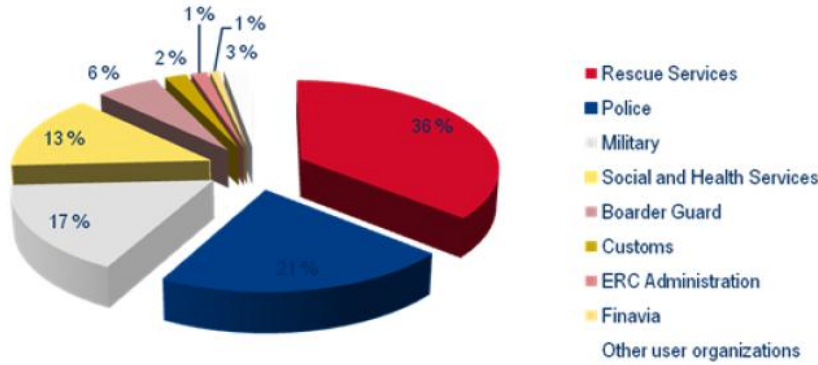

Source: Virveverkko

Virve is also a state-owned non-profit PPDR network. The Finnish national TETRA network is expected to migrate to LTE in the years ahead. Migration towards the evolved TETRA technology will probably be more costly than using an LTE-based commercial network due to higher dedicated PPDR services embarked in the PPDR network.

This step-by-step evolution of PPDR networks is shown in the following graph:

Figure 26: Potential evolution of the PPDR networks

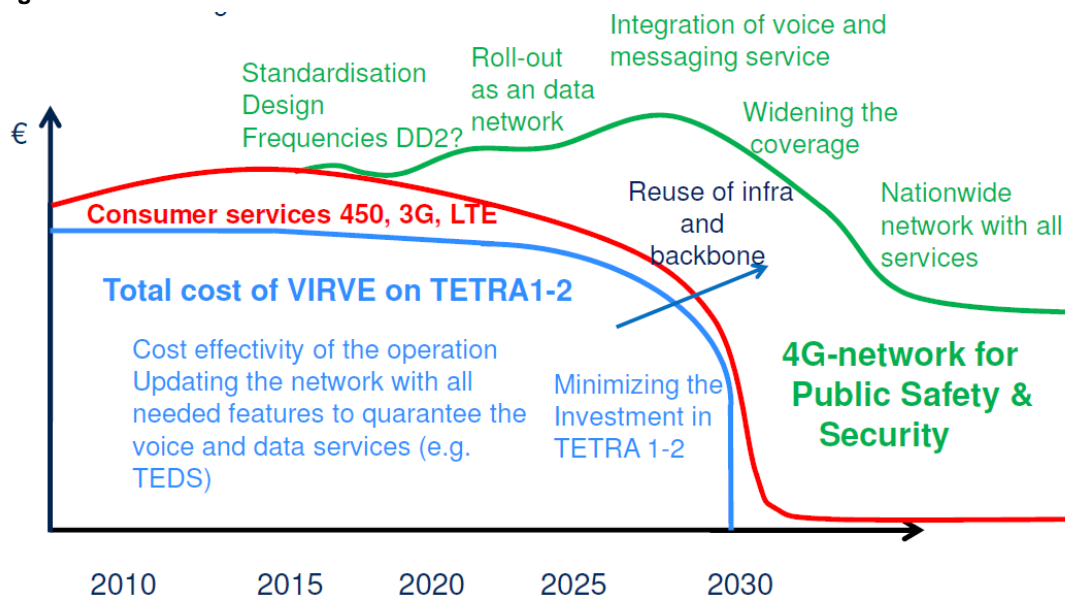

Source: Virve, Mobile data needs and solutions for authorities' networks, Markus Kujala

BOSNet (Germany)

BOSNet covers the whole country in Germany. The network was delivered by EADS Secure Networks (Cassidian). It is owned by the Government. The Federal Agency for Digital radio of Security Authorities and Organisations (BDBOS) is managing the network. BDBOS sets up, operates and ensures the operability of both voice and data in the network. This implementation has been done with the commercial player Vodafone by utilizing the existing base station sites. Alcatel-Lucent is part of the deal.

Airwave (UK)

Airwave is both the name of the network and the name of the private company which operates the network. The Government has the right to accept or reject possible new owners of the company. The network was delivered by Motorola. At the beginning, Airwave was owned by British Telecom (now BT) because most of its base stations and transmission

links were owned by BT and leased to Airwave. Airwave has a 15-year agreement with the UK Government for provision of PPDR services.

Hubone, France

Hubone is a subsidiary of Aéroport de Paris in charge of a secured and independent network aimed at the good operation of the network of Paris airports. It is also responsible for leveraging on this private network with other private players to help monetize the network while contributing to the performance of other private players in the airport.

Between December 2013 and April 2014 performed a trial of an LTE network on band 13 and 28. The aim of this trial was in part to test how LTE with PPDR features could be operated in critical situation and especially in deep indoor environment with bad propagation environment and also to test how this could be interfaced and made interoperable with existing network.

Figure 27: HubOne test infrastructure

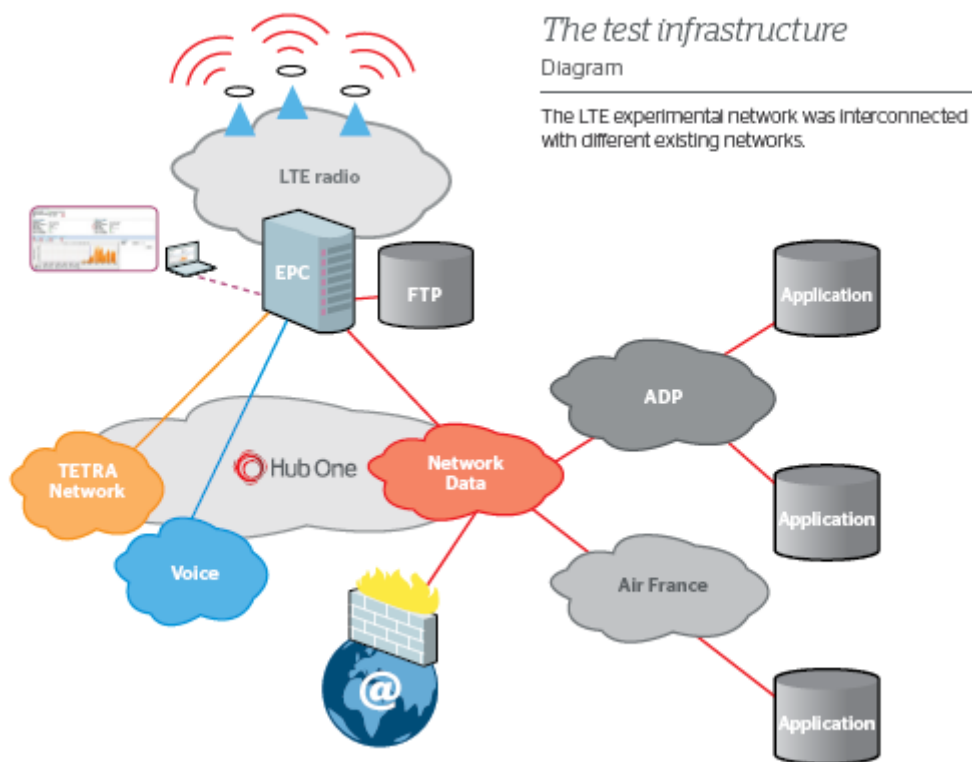

Source: Hub One

Antenna sharing

One key learning of this trial in terms of sharing is the possibility to share existing DAS infrastructures between two different networks (here a TETRA network and a LTE network). During the experiment, using the 400 MHz frequency band and the deployed network of DAS, often found in airport, it was possible to have both a TETRA network and a LTE system, with a guard band of only 1 MHz

QoS and prioritization

In the case of a share RAN, it was also demonstrated that it was possible to secure a certain Quality of Service for most critical services, of which voice services. This is all the more important that some services such as video can use a lot of bandwidth. The QoS can be differentiated depending on the type of service but also the user profile.

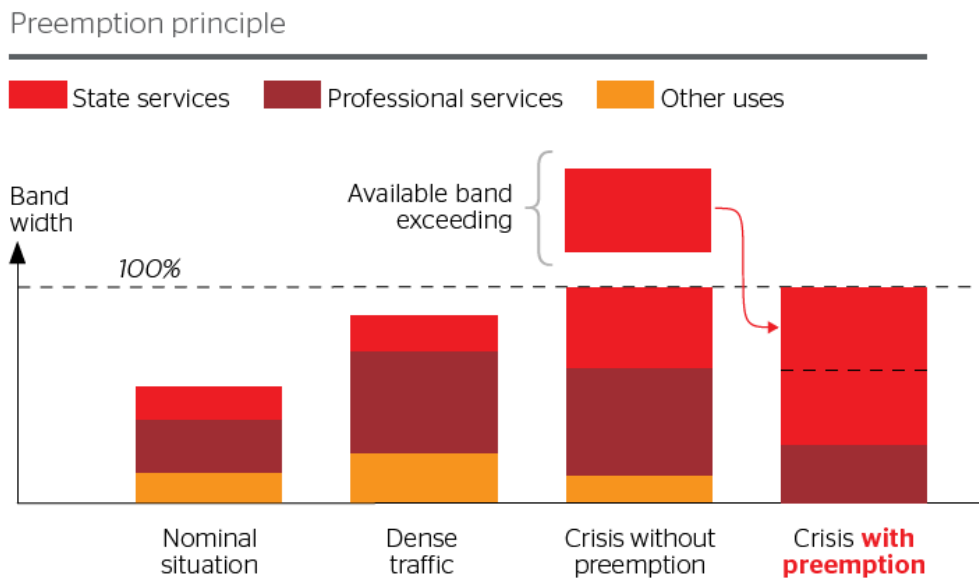
Figure 28: Priority for critical usage

Source: Hub One

HubOne tested two different systems:

- The first one was not exactly R12/R13 compliant (the releases being not issued yet) but the voice and group call feature are completely integrated in the lower layers of the system. That's why we called it so: it was an early design of what the R12 and R13 releases could be about these features. It's a kind of "bottom up" solution. The terminals are built by Huawei itself.
- The other one, the R9 compliant system, implemented voice and group calls with a "top down" solution: we used a client / server solution over an IP link created by the LTE network. The advantages are that this solution can be used on any LTE network but the drawback is that the QoS of the network must very thoroughly checked to ensure the performance and very short delay needed for a PMR usage. The handsets used were Samsung S4 used currently in US.

Firstnet, USA

Presentation

Firstnet is the name of the US Public Safety broadband network, whose creation was decided after the terrorist attacks of 2001 and Katrina Hurricane in 2005. It was established in 2012 and is based on LTE equipment operating on band 14 (700 MHz) with hardened infrastructure but will have in a first phase to work alongside existing networks deployed throughout the country. Public Safety was awarded 2x10 MHz of spectrum.

It will be used by federal, state and local public safety agencies, utility and public transportation companies and others responsible for critical infrastructures with no obligations though. In case where states decide not to use Firstnet network, they will have anyway to provide interoperability with Firstnet network, which means that LTE will have to be supported anyway, in order to be able to roam on Firstnet network outside of coverage of the network.

This possibility for states to decide to get broadband coverage from other operators has been thought in order to enable competition

Will be based on VoLTE and encryption

Ultimately, Firstnet network will encompass between 14,000 and 35,000 base station depending on the states that choose to use Firstnet. It is considered that 38,000 enode B are

required to cover 95% of the population. However given the uncertainty regarding the number of states choosing to rely on Firstnet, the economic viability of the project is at stake and measures are considered to reduce the financial cost of the network. Dropping indoor coverage could for instance help reduce the number of base station required by 14% at 700 Mhz

Sharing

In Firstnet case, the network will be shared with private networks, notably utilities. More generally, depending on the situation, different elements of the network will be shared. Spectrum will notably be shared or leased in parts where frequencies are not used.

Whenever possible, existing assets own by public organization will be used. Sites will be constructed only when necessary. As for the core network it will not likely be shared for security reasons.

5.3.7. Broadband PPDR implementation timeline

Nationwide mission-critical broadband voice plus data (LTE-based) PPDR networks will not be available before at least 2025, according to TCCA. In the meantime, current PPDR providers need to find a new way to offer PPDR services to users. TEDS does not provide the data rates to be used for broadband applications.

The TCCA roadmap below shows a possible migration path from the existing voice/NB data networks towards fully-integrated LTE-based BB data/voice networks. A full integration with available terminals is envisioned in this roadmap around the year 2025 at the earliest.

Figure 29: Possible migration path towards fully-integrated LTE-based BB data/voice networks

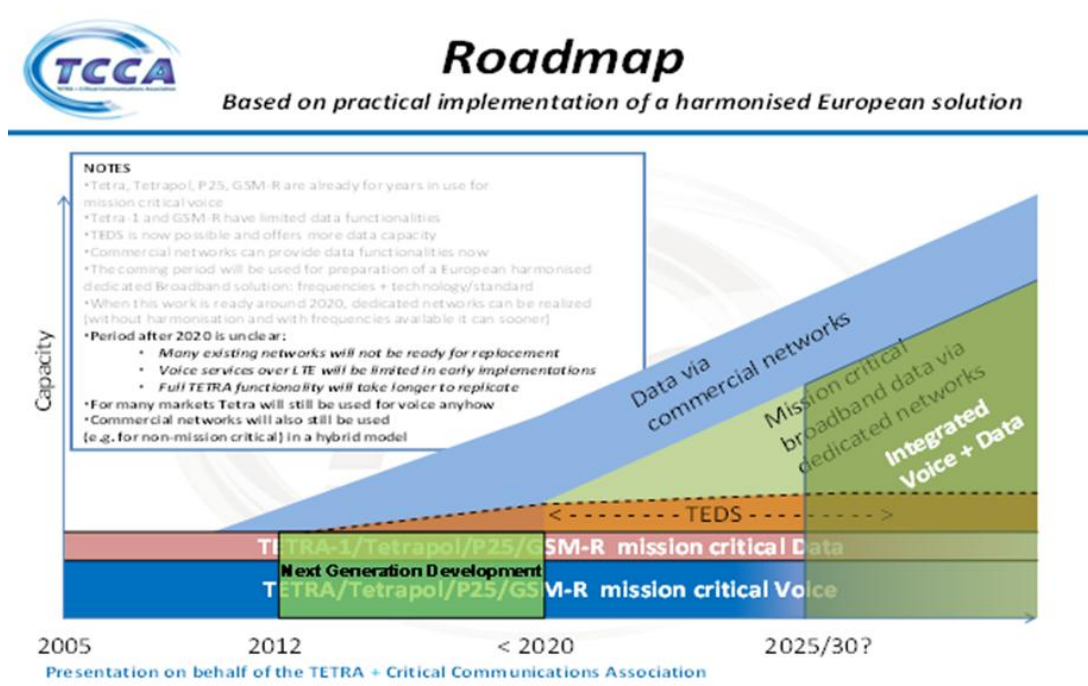

Source: TCCA

We expect the following timeline for broadband PPDR solutions:

Table 15: Timeline for broadband PPDR solutions

Action	Timeline
Use of LTE for public safety	Short term in the USA, medium term in Europe
Network Sharing	Medium to long term

Action	Timeline
Spectrum sharing	Long term

Source: IDATE

5.3.8. Access to broadband capabilities for PPDR players

We have identified the following options for PPDR players wishing to get access to mobile broadband capabilities:

1. Build and run an own dedicated broadband PPDR network
2. Use a dedicated broadband PPDR network run by a private operator
3. Use a narrow band PPDR network + MVNO agreement for broadband services
4. Use a dedicated commercial mobile network
- 4'. Use a standard commercial mobile network
5. Use a dedicated commercial mobile network which operates specific PPDR spectrum

These strategies are summarised in the figure below:

Figure 30: Strategies for public safety users moving to broadband services

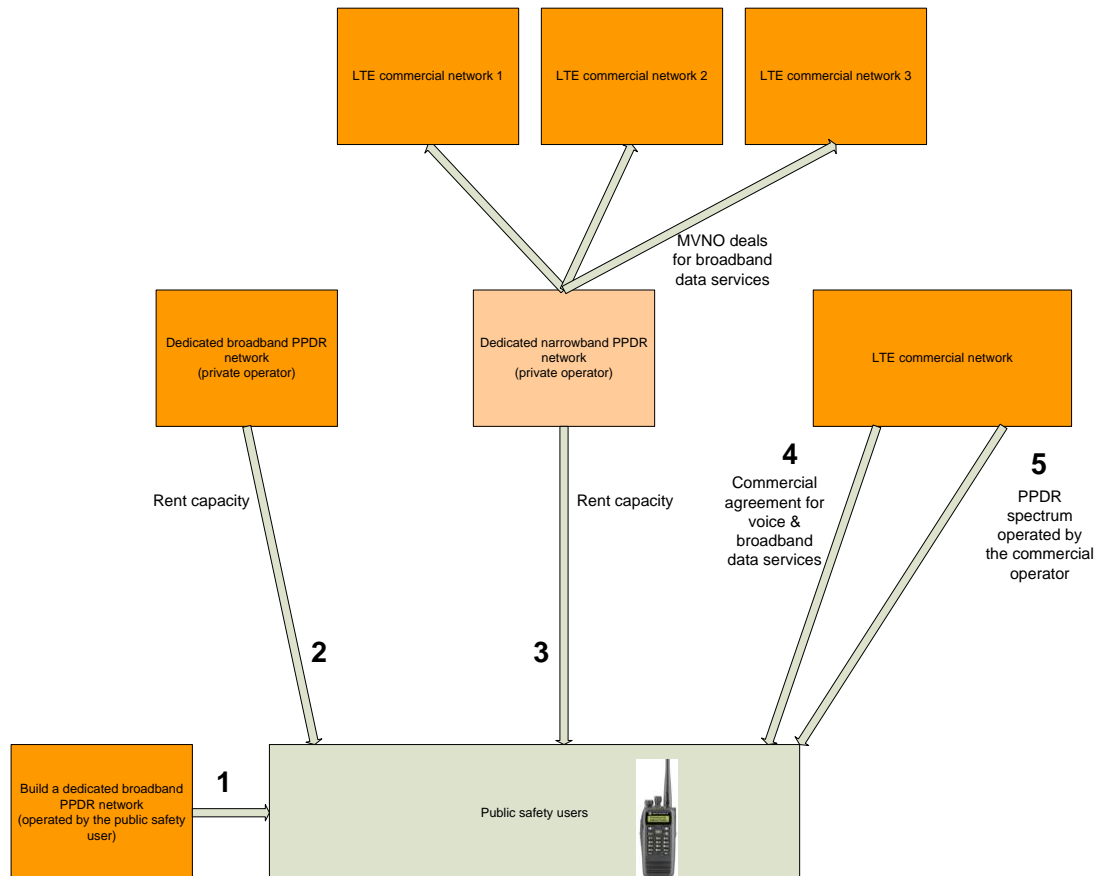

Source: IDATE

Build and run an own dedicated network

Description

The PPDR user builds its own network and operates it.

This is the most common business model for non-broadband PPDR networks in Europe where governments (PPDR services are often government-owned) have invested heavily in

creating an own dedicated network. This model assumes that a dedicated portion of spectrum is allocated to PPDR services as has been done in the past with the 380-400 MHz band in Europe or at NATO level.

The authority finances the equipment and supporting infrastructure, the operation and maintenance support systems. It sets the technical requirements for the network infrastructure with respect to service offering, capacity, security, reliability, redundancy and robustness of the network and supporting infrastructure.

In the USA, the government-owned FirstNet case stands close to this scenario. In the USA, seven grantees are expected to strike separate spectrum-lease pacts – four have been struck so far. FirstNet has resolved roaming issues by partnering with Verizon Wireless.

Advantages

In this model, the network matches the PPDR requirements exactly. Users have full control of the network.

Disadvantages

The disadvantages with dedicated network infrastructure for PPDR are additional costs (capex and opex).

Spectrum harmonisation is highly required to be able to offer a seamless service. Dedicated spectrum is unlikely to be awarded before 2015 or even later. It must be cleared of any previous service. In most European countries, such a costly dedicated network will be difficult to fund in the current bad economic climate, even if the network can be used and amortised by a few PPDR users to minimise costs.

Spectrum

Dedicated broadband PPDR spectrum allocated to the PPDR player is used.

Use a dedicated PPDR network (run by a private operator)

Description

This dedicated broadband network is built by a MNO or a consortium of MNOs or an independent operator and provides services to PPDR users. This model already exists in the non-broadband PPDR ecosystem with PMR networks (Astrid in Belgium, Virve in Finland and Airwave in the United Kingdom).

One option could be to use a dedicated PPDR network which operates as a wholesaler. Once the LTE-based dedicated PPDR network is built and operated by a provider, usage of the network can be shared among several users. It is close to a wholesale business model. It seems to be a second-step strategy supported by TETRA players. The main advantages of this option lie in capex and opex reductions.

Any excess capacity on the PPDR network can be sold to commercial users. In addition, some infrastructure elements can be share among commercial users with significant capex savings for the network owner.

According to Thomas Welter, Chief Frequency Officer of SFR, mobile operators, notably SFR, “are in a very good position to build and operate such professional networks through public-private partnerships, and we may also benefit from additional roaming on our public mobile networks”.

Advantages

There are many requirements and conditions for the use of PPDR, which lead to the need to use dedicated PPDR networks.

Key benefits of this model are that PPDR users are the only companies using the network. It is designed especially to meet PPDR-specific requirements. Control can be exercised in terms of latency, prioritisation, coverage, resilience and other factors.

In addition, most PPDR organisations have a strong preference for a dedicated network, TETRA for example.

Disadvantages

The disadvantages with dedicated network infrastructure for PPDR are additional costs (capex and opex). Some elements of the physical infrastructure (antenna sites and backhaul) may however be shared with MNOs to reduce infrastructure costs.

Dedicated broadband PPDR spectrum is required, but allocation of dedicated portions of spectrum is still being debated, notably in Europe. Upfront investment can thus be expected to be very high.

Spectrum

Dedicated broadband PPDR spectrum allocated to the private operator is used.

Use a commercial mobile broadband network

In order to get access to mobile broadband capabilities, public safety users can use existing mobile broadband networks through various agreements:

- Use a commercial mobile network;
- Use a MVNO.

Use a narrow band PPDR network + MVNO agreement for broadband services

Description

A PMR network – a typical example is Astrid in Belgium, or Virve in Finland or Airwave in the United Kingdom – does not have the financial resources to build a broadband mobile network such as a LTE network. The private operator signs a MVNO deal with a mobile broadband operator in order to get access to mobile broadband capacity and packages the service for its PPDR customers.

Advantages

- Relatively low upfront investment
- Short time to market
- Increased coverage

Disadvantages

- Services limited to basics
- High requirements may not be met (coverage, availability, resilience of the network)

Spectrum

The spectrum from commercial network operators is used.

Use a commercial mobile network

Two distinct scenarios can be implemented in this model: in the first scenario, the commercial operator provides no specific service. In the second scenario, the mobile operator adapts to the PPDR requirements and implements specific redundancy features.

Description

Basically, the user can strike a deal with a MNO for the provision of mobile broadband services. This option is especially feasible when requirements are not really mission-critical. If they are, the deal should include additional services to meet PPDR requirements such as priority access, or network redundancy in case of network outage.

Advantages

This strategy offers good geographical and population coverage and satisfactory data rates. The key advantage of this option is that it is quite easy to implement: MNOs using 3G and even 4G technology already exist in almost every country in the world. They often offer good geographical and population coverage and satisfactory data rates. This option appears very

cost effective with no upfront investment required and low operational costs, and can be implemented fast. In addition, standard devices can be used.

Disadvantages

However, in the first scenario, service may be limited to basics (no direct mode, group calling... as mentioned earlier) before freezes of Release 12 or 13 not scheduled before end-2015, at the latest.

Spectrum

The spectrum from commercial network operators is used.

Use a dedicated commercial mobile network which operates specific PPDR spectrum

Description

Broadband PPDR spectrum is allocated to the PPDR user which decides to share it with a commercial mobile broadband operator.

Advantages

- Several users and re-selling of excess capacity
- Network is specifically designed to meet PPDR requirements
- Several users justify the construction of a network. Funding may be easier.

Disadvantages

- Difficult to fund in today's economic climate
- Lower capex if re-selling of excess capacity

Spectrum

PPDR spectrum allocated to the PPDR user is shared with the commercial operator.

Table 16: Strategies overview

Strategy	Advantages	Disadvantages	Spectrum
1. Build and run an own dedicated broadband PPDR network	Network is specifically designed to meet PPDR requirements. High upfront investment (often financed by governments) and operational costs (can be reduced if multiple users)	Higher capex (than previous options), high opex Difficult to fund in today's economic climate Dedicated broadband PPDR spectrum is required	Dedicated PPDR spectrum operated by the PPDR user
2. Use a dedicated broadband PPDR network run by a private operator	No investment from the PPDR user Network is specifically designed to meet PPDR requirements	No control on coverage, service development	PPDR spectrum operated by the private operator
3. Use a narrow band PPDR network + MVNO agreement for broadband services	Relatively low upfront investment Short time to market Increased coverage	Services limited to basics High requirements may not be met (coverage, availability, resilience of the network)	No specific PPDR spectrum
4. Use a dedicated commercial mobile network	Network is specifically designed to meet PPDR requirements. No alternative user	Difficult to fund in today's economic climate	Commercial mobile broadband spectrum

Strategy	Advantages	Disadvantages	Spectrum
4'. Use a standard commercial mobile network	<p>3G/4G networks already in operation in many countries</p> <p>Network is designed to meet some PPDR requirements</p> <p>Cost-effective solution (Low upfront investment, use of standard devices, low operational costs)</p>	<p>Services limited to basics</p> <p>High requirements may not be met (coverage, availability, resilience of the network)</p>	Commercial mobile broadband spectrum
5. Use a dedicated commercial mobile network which operates specific PPDR spectrum	<p>Several users and re-selling of excess capacity</p> <p>Network is specifically designed to meet PPDR requirements</p> <p>Several users justify building of a network.</p> <p>Funding may be easier</p>	<p>Difficult to fund in today's economic climate</p> <p>Lower capex if re-selling of excess capacity</p>	PPDR spectrum allocated to the PPDR user is shared with the commercial operator

Source: IDATE

5.3.9. PPDR networks and railways specific needs

All indications are that, if such a network exists at all, it will be based on LTE, and will presumably be able to use standard LTE capabilities; thus, considerations are similar to those already noted for an MNO network with LTE.

A PPDR broadband network would likely meet most needs for rail with no special accommodations.

- Reliability/robustness requirements are at least as great.
- Bandwidth would be more than sufficient.
- Prioritisation requirements are at least as great.
- Coverage for all relevant rail lines would be required as PPDR coverage of the railway tracks is probably limited today.

ERTMS/ETCS modifications would presumably be the same as with a standard public MNO network.

Today, the railways stakeholders are taking into account this option and many comments were made during the two workshops held in 2014:

- UIC is considering sharing a PPDR network as a serious scenario for the future railways communications system.
- The Finnish Infrastructure Manager indicated they will be using TETRA networks for railways communications, but only for voice, not data.
- In the United Kingdom, Network Rail is wondering who would own/control the communications network (the entity who owns the network will have full control over it).
- There were some comments on the costs of this network. It was noted that the fixed part of the network should be shared (by PPDR and utilities). The study team indicated this is a very small part of the total costs.

5.4. Support for GSM-R specific features

GSM-R support some features that are not found on commercial cellular technologies such as LTE and that will have to be supported in order to make a suitable technology for the railway industry.

Those features are listed in the table below

- ETCS: it is currently GSM-R dependent and will have to be made bearer independent in order to work with any other possible radio technology
- Voice services: those services rely not just on subscriber identity but also on the belonging to groups, making possible to pass calls, not only to specified subscribers but to all the persons belonging to a defined group. With those services preemption capability is particularly important.
- In order to function in a train environment, especially in fast moving environment, some capabilities have to be supported, such as fast handover, fast call set up and more generally, support for speeds up to 500 km/h

Table 17: Review of GSM-R features and their possible operation on TETRA and LTE networks

Technology	GSM-R	TETRA	Dedicated LTE	Commercial LTE
Frequency bands	876-880 (mobile stations) and 921-925 MHz + fallback capabilities on GSM Frequencies	380-420, 410-430 and 450-470	450-470 MHz? APT 700 MHz	700, 800, 900, 1800, 2100, 2600, 3500 MHz
Carrier aggregation	no	no	Rel 13 ?	LTE Rel 10 and onward
ETCS	X (ETCS needs to transfer up to 500 bytes in less than 2s (99%))	NA		
speed guidance	Level 2	used with TETRA in Kazakhstan	Requires to make ETCS bearer independent to act as an application layer working with any technology	
train location		used with TETRA in Kazakhstan		
movement autorisation	Level 2	used with TETRA in Kazakhstan		
train spacing	Level 3 (in development)	Used with TETRA in Kazakhstan		
Voice services				
functionnal numbers	X	X	require a modified HLR with a database to store group areas and group IDs + localization services	
one to one voice call	X	X	X (VoLTE) or CSFB to GSM-R	
Push-to-talk	X	X	Rel 13 or CSFB to GSM-R	
Group calls	X	X	LTE Rel 12 or CSFB to GSM-R	
Voice Broadcast Service	X	X	use of proximity services, D2D and possibly LTE broadcast required	

Technology	GSM-R	TETRA	Dedicated LTE	Commercial LTE
Railway Emergency calls	X	possible to implement	Voice Group Call with priority to be implemented + ETWS (Earthquake and Tsunamis Warning System, based on eMBMS)	
Preset numbers for specific functions	X			
Shunting mode	X		To be implemented. It requires a Link Assurance Signal to be provided to certify that the radio link is working + proximity services	
Geolocation capability	X (required for ETCS Level 2)	X	to be implemented on the application layer	
Data capabilities (kbps, mbps)	2.4, 4.8 and 9.6 kbps (used for ETCS)	up to 500 kbps with TEDS but theoretical throughputs rarely reached (for 150 khz of bandwidth)	LTE 450 in Finland provided will enable Average throughputs of 3-10 Mbps (DL) and 1-3 Mbps (UL) with a maximum of 6 Mbps	Up to 150 Mbps for 20 MHz of spectrum (theoretical)/ 50 Mbps in upload
Enhanced Security (encryption)		X		
Support for high speed (up to 500 km/h)	X (EIRENE MORANE)	No	Need further standardization to reduce Doppler effect	
Resilience capability (maintain some basic functions in case of damages in the network)			Worked in Rel 13	Worked in Rel 13
Latency capabilities	several seconds with GPRS, 800 ms with EDGE		50 ms	50 ms
Average number of handsets/devices per base station		In Europe, 64 users per TETRA sites	200 users per enodeB for each 5 MHz of spectrum	
Availability of handsets	available	available	end of 2017-2018?	available

Source: IDATE; X means that the service is supported by the technology

5.4.1. ETCS

In order for the European Train Control System to work with LTE, it will be required to decouple it from the radio technology and make it bearer independent. In the end, ETCS will be able to operate as an IMS application with specific/guaranteed Quality of Service, something that LTE enables.

Specifically, ETCS requirements are manifold. ETCS messages of 128 bytes must notably be transferred in less than 0.5s and 95% of messages must be delivered within 1.5s. Simulation tests have shown that an LTE system could satisfy those criteria, with speed from 25 to 500 km/h, something that is required by GSM-R requirement.

What is also important is the capability for LTE to transfer ETCS messages with limited data loss, data duplication, data being out of sequence and data corruption. This is also something that was successfully simulated, demonstrating the effectiveness of LTE combined multilayer error detection and correction mechanisms

That simulation however only shows that LTE can sustain the transportation of ETCS message. As explained before, ETCS will have to be developed as an IMS application to run over LTE. In a first transition phase, ETCS will probably still be carried over GSM-R while voice (and other data applications) will be carried over LTE.

It is to be noted that in South Korea, an ETCS Level 2 like signaling technology has been tested over LTE with LTE Release 9 equipment at speeds up to 350 km/h. In 2015, tests at higher speed should be undertaken.

Figure 31: Transfer delay of ETCS messages delivered over LTE during a simulated test performed based on a railway line between Snoghøj and Odense

Train Speed [km/h]	Single train scenario		15 train scenario	
	Mean transfer delay [s]	Messages delivered within 1.5 s [%]	Mean transfer delay [s]	Messages delivered within 1.5 s [%]
25	0.050	100 %	0.050	100 %
50	0.050	100 %	0.052	100 %
75	0.051	100 %	0.051	100 %
100	0.051	100 %	0.050	100 %
125	0.051	100 %	0.053	100 %
150	0.052	100 %	0.051	100 %
175	0.052	100 %	0.055	100 %
200	0.053	100 %	0.055	100 %
250	0.053	100 %	0.056	100 %
300	0.055	100 %	0.058	100 %
350	0.056	100 %	0.054	100 %
400	0.058	100 %	0.057	100 %
500	0.063	100 %	0.063	100 %

Source: Performance of LTE in High Speed Railway Scenarios Impact on Transfer Delay and Integrity of ETCS Messages (A. Sniady and J. Soler), May 2013

5.4.2. Voice support on LTE

The support of voice is critical for railway operation and the technology that will replace GSM-R will have to be able to provide the same services than GSM-R with the same requirement. While GSM-R is a circuit switched technology, a technology such as LTE is an all-IP technology, meaning that voice itself will be treated as an IP service with all the quality of service requirement that LTE and IMS enable.

Those services will be primarily based on Voice Over LTE, which is the standard that is supported by most operators and equipment manufacturers and that run as an IMS application. Despite the fact that first deployments by commercial operators have taken longer than expected to happen (especially because of the complexity of IMS), it seems like 2014 has been a turning point for the technology adoption with several tier 1 operators deploying and launching VoLTE services during the year (among which T-Mobile US, AT&T, NTT Docomo, Verizon...).

Voice services based on VoLTE will have to satisfy RAMS requirements, where RAMS stands for Reliability, Availability, Maintainability and Safety. Those requirements will have to

be fulfilled at speed up to 500 km/h. According to players we interviewed, the support of speeds up to 500 km/h is not an issue, it is rather a standardization only issue. The standardization will have to make the influence of Doppler frequency change the smallest possible, something that is also linked to the frequency band on which the network is operated.

In November 2012, Ericsson performed test with LTE in an aircraft reaching the speed of 700 km/h at low altitude (300m above the ground) and were able to sustain a communication at that speed, reaching throughputs of 20 Mbps on a commercial network⁹. Specifically, moving straight toward a base station at speed over 600 km/h, the network was capable of sustaining throughputs up to 20 Mbps. At 500 km/h, handover between base stations were demonstrated, without visible disturbance to the video stream that was used to monitor the stability of the internet connection.

5.4.3. EIRENE / MORANE

EIRENE stands for European Integrated Railway Radio Enhanced Network/ It is a set of specification that makes GSM-R different from GSM. There are two different specifications for GSM-R, Functional Requirement Specification (FRS) that define the higher level functional requirement and System Requirement Specifications (SRS) that define the technical solutions required to support functional requirements.

EIRENE FRS list the system services that need to be supported. Figure 32: List of system services that are required by EIRENE FRS below list those services.

Those services could be supported over LTE through the combination of different features that are currently being standardized in LTE Release 12, 13 and some of them will probably see their standardization postponed to a further release, should no consensus emerge within the working group.

Those features are Group Calls, proximity services, Device to Device and relay features which are close features. LTE broadcast (eMBMS) could also be used for even more efficient communication but functions similar to ETWS (Earthquake and Tsunami Warning System) specified in LTE Release 8 within 3GPP could be also used.

Figure 32: List of system services that are required by EIRENE FRS

- voice services:
 - point-to-point voice calls;
 - public emergency calls;
 - broadcast voice calls;
 - group voice calls;
 - multi-party voice calls;
- data services:
 - text message bearer service;
 - bearer service for general data applications;
 - bearer service for automatic fax;
 - bearer service for train control applications;
- call related services:
 - closed user group;
 - multi-level priority and pre-emption;
 - advanced call handling, such as call hold, call transfer, call queuing, etc;
 - auto answer service;
 - barring incoming or outgoing calls;
 - call supervisory indications;
 - charging information;
- railway specific applications:
 - support for functional addressing by train, engine or coach number or functional number;
 - call specific persons depending upon user location;
 - specific mode for shunting operations providing a link assurance signal;
 - multiple driver communications within the same train;
 - railway operational emergency calls;
- direct mode facility for local set-to-set operation without network infrastructure;
- railway specific features:
 - set-up of urgent or frequent calls through single keystroke or similar;
 - display of functional identity of calling/called party;
 - fast and guaranteed call set-up;
 - seamless communication support for train speeds up to 500 km/h;
 - automatic and manual test modes with fault indications;
 - control over mobile network selection;
 - control over system configuration.

Source: EIRENE FRS v7

⁹ http://www.ericsson.com/news/121101-ericsson-tests-lte-in-extreme-conditions_244159017_c

5.5. Cost of existing networks

5.5.1. GSM-R

The GSM-R network has this specific that coverage only needs to be provided along the track, which enables to significantly reduce the cost as compared to other kind of network where coverage is to be provided either in terms of population coverage, spread all over the territory, either in term of geographic land mass coverage.

Sites along the tracks are usually owned by the railways and equipped with various technologies. Depending on the traffic density on the lines, locomotives and tracks are equipped differently, GSM-R and ETCS being reserved for most important areas.

ETCS equipment vary depending on the level that is implemented. GSM-R is required only starting with ETCS level 2, where signaling is transmitted through GSM-R. ETCS is to be deployed on all tracks that are used by international trains as a means of interoperability in Europe.

It is estimated that only 4% of kilometers of lines are currently equipped with ETCS.

In terms of backhaul, fiber is often available along the tracks.

Locomotives that are operated on GSM-R equipped track must support GSM-R through GSM-R cab radios. The cost to mount such a radio on a locomotive is estimated around 27,000 EUR but most of those costs are not specific to GSM-R but would anyway exist whatever the radio technology used.

Table 18: Indicative cost elements for GSM-R networks

EUR '000	GSM-R
CAPEX	
<i>voice only (per km of line)</i>	25
<i>voice+etcs (per km of line)</i>	30
<i>voice only cab radio (per locomotive)</i>	20
<i>ETCS only cab radio (per locomotive)</i>	25
OPEX (% of CAPEX)	10%
Coverage (%pop/geographical)	
<i>ETCS coverage (% of European lines)</i>	4%
<i>km of lines covered by GSM-R</i>	70 211
<i>km of lines to be covered by GSM-R</i>	154 284
Availability	

Source: ERA, and European commission (SCF)

5.5.2. TETRA/TETRAPOL

It is estimated that around 23,400 TETRA base stations are deployed in Europe serving around 1.5 million users in Europe, ranging from governmental organization, public safety to utilities. TETRA and TETRAPOL users' needs are quite different from the needs of GSM-R users even though they may have similar requirement.

As noted in part 5.5.1, the coverage requirements are quite different since complete portions of territory have to be covered (sometimes whole territory), including indoor, which makes a huge difference in terms of coverage requirement. TETRA and TETRAPOL use low frequencies in the 400 MHz range.

In terms of usage, the resilience of the network is very important for voice. Group Call, Push To Talk and Direct Mode Operations are very important for those users. One difference though with GSM-R is the fact that Direct Mode Operation is not a requirement for them and is not used on the ground.

In terms of backhaul, microwave is often used.

Table 19: Indicative cost elements for TETRA/TETRAPOL networks

EUR '000	TETRA
CAPEX	
<i>per TETRA/TETRAPOL sites</i>	1400
<i>per handset</i>	900
<i>per cab radio (in car)</i>	2000
OPEX (% of CAPEX)each year	9%
Coverage (%pop/geographical)	
<i>number of sites in EU+Norway</i>	23450
<i>number of TETRA/TERAPOL users ('000)</i>	1500
<i>number of user per site</i>	64
Availability	

Source: European commission (SCF)

Table 20: Presentation of selected TETRA networks in Europe

Public safety TETRA networks	Number of users	sites	cost (EUR bln)	Cost per site (K EUR)
Austria	80 000	1800	1.1	611
Belgium	10 000	600	0.4	667
Denmark	20 000	500	0.2	400
Finland	30 000	1400	0.3	214
Germany	500000	4500	1.1	244
Italy	200000	3100	3.5	1129
Netherlands	85 000	600	0.5	833
Norway	40 000	2000	0.9	450
Sweden	50 000	1800	0.4	222
UK	300000	3500	5.5	1571

Source: Analysys Mason

5.5.3. LTE

As a technology used for commercial networks and heavily standardized, LTE costs related to equipment are less important than cost for niche markets such as the Railway market and Public Safety. The requirements are also far less important.

It can be operated in very different frequency bands from the 450 MHz bands, being standardized for Brazil and few other countries notably, to 3.5 GHz (3GPP band 22 and 42), little used for the moment but for which there is a growing interest, especially for densely populated areas

It is generally admitted that in a network using a cellular technology such as LTE, the RAN network account for 70-80% of the costs while the core network accounts for the remaining 20-30%

Depending on the bandwidth available for operation, the backhaul will differ, fiber and microwave being the technology the most used for that matter. Microwave can support very different capacities and latencies depending on the frequency bands and the technology used. Latest microwave technologies can support throughputs of more than 1 Gbps. It is used in areas where density of population doesn't make an economic case for the deployment of fiber.

Commercial LTE sites are not rugged and cannot be used as such for critical communication. It can secure the Quality of Services but require hardening in order to remain usable in the event of power breakage for instance.

Table 21: Indicative cost elements for a commercial LTE networks

EUR '000	Commercial LTE
CAPEX per LTE site	79.38
<i>tower equipment</i>	56.7
<i>eNode B price</i>	50
<i>microwave backhaul per hop</i>	30
<i>microwave capex per site (Vodafone)</i>	37%
<i>MIMO antennas (each)</i>	1822.5
<i>RRH (each)</i>	3948.75
<i>Fibre cable (per foot)</i>	0.243
<i>Power cable (per foot)</i>	0.0405
<i>Engeneering and installation(% of equipment cost)</i>	40%
OPEX (% of CAPEX)	around 20% of CapEX
Coverage (%pop/geographical)	
Availability	

Source: IDATE based on Alcatel Lucent

5.5.4. LTE Rugged

The hardening of LTE sites is made necessary to secure the providing of critical communication over LTE in the case of power outage for instance. Essentially, it boils down to power redundancy in order to be able to provide backup power for up to several days.

Table 22: Indicative cost elements for a ruggedized LTE networks

EUR '000	rugged LTE
CAPEX per LTE site	125.38
<i>hardening cost per site</i>	46
<i>tower equipment</i>	56.7
<i>eNode B price</i>	50
<i>microwave backhaul per hop</i>	30
<i>microwave capex per site (Vodafone)</i>	37%
<i>MIMO antennas (each)</i>	1822.5
<i>RRH (each)</i>	3948.75
<i>Fibre cable (per foot)</i>	0
<i>Power cable (per foot)</i>	0.0405
<i>Engeneering and installation(% of equipment cost)</i>	40%
OPEX (% of CAPEX)	around 20% of CapEx
Coverage (%pop/geographical)	

Source: IDATE based on Alcatel Lucent and FCC

5.5.5. Variation in cost with frequencies

It is estimated that capex at 700 MHz is 44% more than capex at 400 MHz. Similarly, OPEX change similarly to the number of sites required.

Figure 33: Relation between base station site numbers and operational frequency

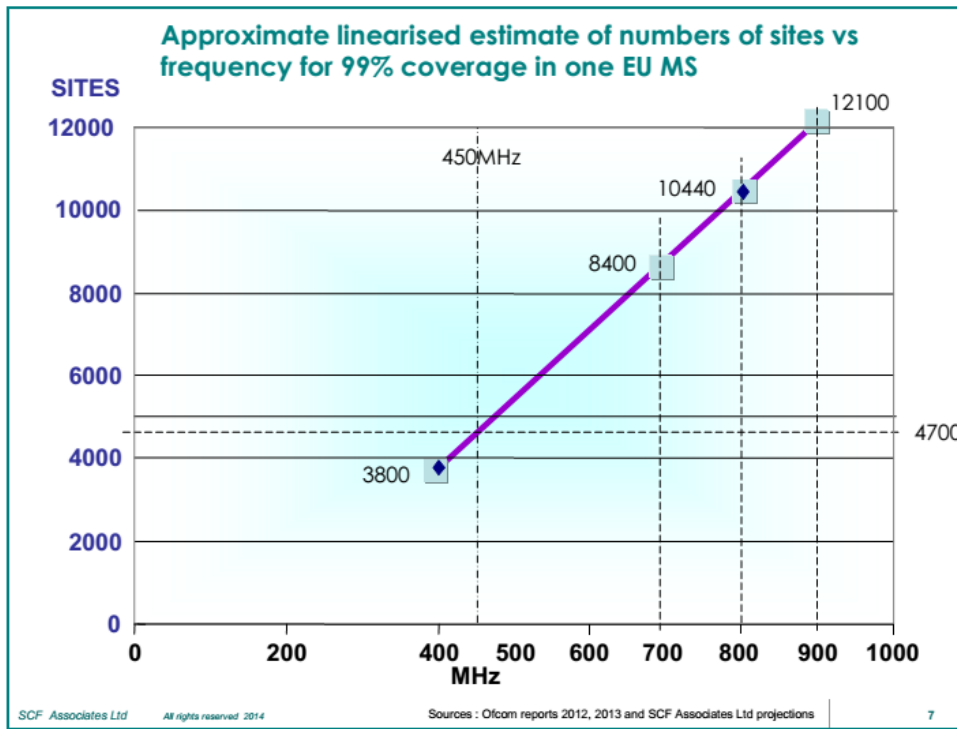

Source: SCF

6. Annex 6 - Literature review

This section of the study summarises key relevant literature and prior studies. Section 6.1.1 provides an overview of the Final Report “Survey on operational communications (study for the evolution of the railway communications system)” (Analysys Mason, 2014), while Section 6.1.2 reviews the Draft Final Report “Is Commercial Cellular Suitable for Mission Critical Broadband?” (SCF, 2014).

6.1.1. Survey on operational communications (study for the evolution of the railway communications system)

A previous study performed by Analysys Mason¹⁰ (to February 2014) listed 6 options to be considered for the evolution of GSM-R. The Terms of Reference for this project called on us to use these as an initial point of reference for the current study.

Options identified (per the Analysys Mason report)

The previous Analysys-Mason study listed 6 options to be considered for the evolution of GSM-R.

In the previous study, the options available relate to the policy to be recommended for adoption for Europe and the extent and nature of the regulations that are to be prescribed.

Figure 34 : Options in the Analysys Mason report

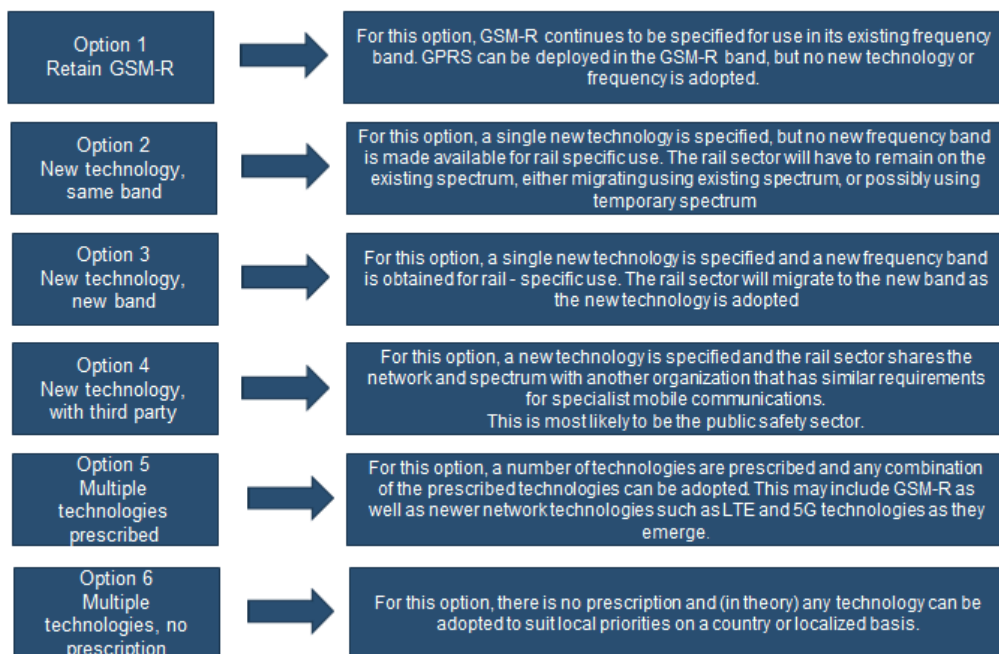

Possible scenarios

Depending on the policy option adopted (O1– O6), different scenarios can be implemented to replace the current use of GSM-R.

¹⁰ Analysys Mason - Survey on operational communications (study for the evolution of the railway communications system) - Final report for the European Railway Agency - 25 February 2014 - Ref: 37760-496v04

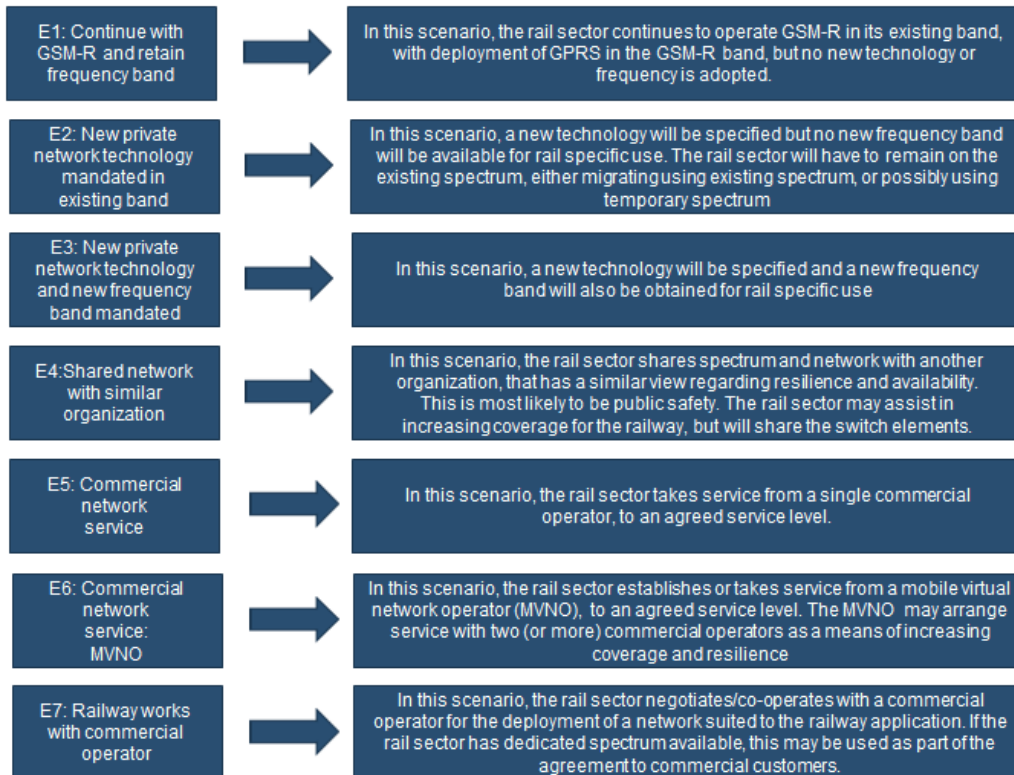
Figure 35 : Scenarios in the Analysys Mason report

Some of these scenarios could apply to multiple options within the tree, e.g. a new technology in a new band (O3) might be delivered using a commercial network or a private network, depending on the detail of the technology and bands adopted.

Figure 36 below shows the options tree with the example scenarios applicable to each option.

Note that where an option shows multiple scenarios, it is possible for combinations of multiple scenarios to be adopted across different countries or regions.

Figure 36 : Options and scenarios in the Analysys Mason report

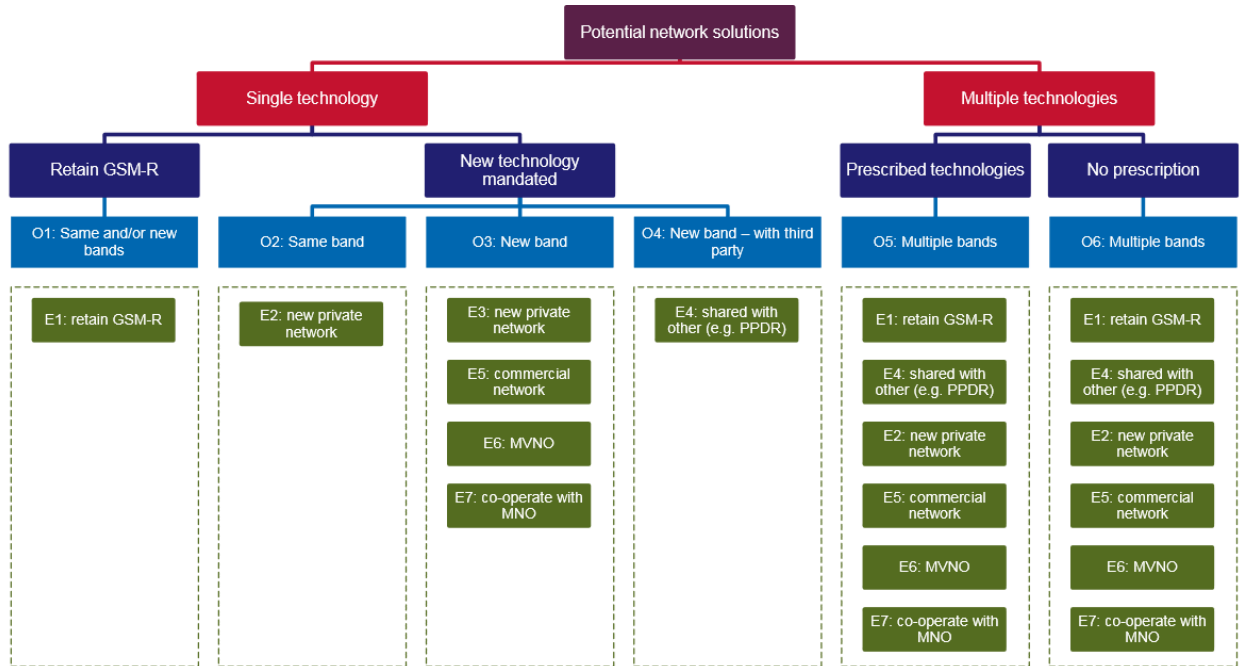

6.1.2. Is Commercial Cellular Suitable for Mission Critical Broadband?

This section presents our synthesis of the final report of the study - *SCF (2014), Study on use of commercial mobile networks and equipment for "mission-critical" high-speed broadband communications in specific sectors– final report - A study prepared for the European Commission DG Communications Networks, Content & Technology, 2014.*

Summary

This study examines the requirements, relative costings and possible implementations of broadband mission critical radio networks for three sectors – public protection and disaster relief (PPDR), utilities and intelligent transport services (ITS) for road and rail. Such services have traditionally been voice oriented, with dedicated networks having exclusive spectrum. New digital applications, such as smart grids for utilities, live video links for medical imaging and policing, call for broadband data. At this time, Europe's mobile network operators (MNOs) are rolling out mobile broadband based on the next generation of mobile technology for broadband (LTE). However, there is some reluctance within the mission critical sectors to employ commercial mobile services exclusively. Their major reservation is whether commercial operators are willing and able to provide long-term reliable and resilient services with the needed coverage and quality. Consequently the European Commission requested an independent study assessing the viability of future commercial mobile broadband networks for these applications. The study considered five options for implementation, analysing cost-benefits to compare them. The key conclusion is that commercial LTE networks could support mission critical needs but only if certain conditions are met. These conditions would fundamentally change the operating environment for the commercial mobile networks.

Purported conditions for commercial mobile broadband networks to be used for mission critical purposes

The recent study SCF (2014)¹¹ indicates that it is possible for commercial mobile broadband networks to be used for mission critical purposes if five conditions are met.

The five conditions that SCF identified are linked to assumptions that they made about the likely policy direction to be followed. In this study, we are considering a different and substantially broader range of candidate policy instruments; consequently, we will need to assess the degree to which the preconditions that they identified are relevant. Aside from that, we have our doubts about the way in which several of the conditions that they put forward are formulated.

The five conditions (which must be met in full) are these:

1. First the behaviour of commercial MNOs must be constrained to provide the services needed by mission critical users while preventing the use of “lock in” techniques to take unfair advantage of this enhancement of the MNOs’ market power and social responsibility. Such changes include not just stronger commitments to network resilience, but the acceptance of limits on price increases and contract condition revisions, ownership continuity assurances, and a focus on quality of service for priority mission critical traffic. Equally important for long-term relationships will be the mission critical services’ perception of MNO behavior and performance. For that, measures will be needed that go beyond service level agreements (SLAs) at a commercial contract level: new regulations regarding commercial MNOs services must be enforced by each Member State’s national regulatory agency (NRA).

2. Commercial networks have to be “hardened” and modified to provide over 99% availability – with a target of “five nines”. Geographic coverage must also be extended as needed for mission critical purposes and indoor signal penetration improved at agreed locations.

3. All this network hardening and extended coverage, along with the addition of essential mission critical functions and resilience, must be accomplished at reasonable cost. No more should be spent on the expansion and hardening of commercial networks for mission critical use than it would cost to build a dedicated national LTE network for that purpose. (One of our findings is that modifying existing commercial networks would in most cases be much less expensive than building a dedicated network.)

4. Hardened LTE networks must be able provide the different types of service required by each of the three sectors. Each sector uses broadband in quite different ways. That is, not just for streaming video, image services and database access, as in PPDR, but for very low-latency telemetry and real-time control for utilities and transport. In the five network options examined in Chapter 4, accommodating the needs of the different sectors becomes easier as one moves from TETRA to LTE and then to more complex hybrid configurations.

5. However, there is a further high barrier: will commercial mobile networks be able to overcome ingrained Member State preferences for state controlled networks for applications that implicate public safety? This is not simply a legal, regulatory or economic question. Some Member States have specific histories of state control as part of their culture, traditions and politics, not to mention investments in current technologies with long payback cycles. Thus some Member States may want to continue using dedicated networks in the short and medium term even if they cost more – examples are Germany, Italy and France for PPDR. However, it cannot be said that they will always ignore cheaper alternatives. The MNOs may need to be more persuasive in putting forward their advantages. In the meantime, it must be left to Member States to choose.

¹¹ SCF (2014), Study on use of commercial mobile networks and equipment for "mission-critical" high-speed broadband communications in specific sectors –final report - A study prepared for the European Commission DG Communications Networks, Content & Technology, December 2014.

Synthesis

This synthesis also integrates the comments made during the public presentation of the study in Brussels (November 26, 2014).

Objective

The objective of the SCF Associates study is to assess the options for mission critical communications utilising mobile broadband in three sectors

- public protection and disaster relief (PPDR, principally police, fire and emergency medical services),
- utilities (electricity, gas and water)
- Intelligent transport systems (ITS) now entering service, with a focus on road and rail.

Two configurations are considered here:

- Public land mobile networks (PLMNs) operated by traditional MNOs
- Dedicated networks for these 3 applications

European status & background

Traditionally, each sector had its own dedicated networks, often with exclusive spectrum allocations. As for illustration, according SCF Associates estimates, PPDR receive significant CAPEX (over 19 billion EUR), mainly invested in TETRA and TETRAPOL technologies, even though there are limited potential to support new data services.

European rail networks are currently deploying a 900 MHz service, based on their own private voice and narrowband communications networks, using a variant of GSM (GSM-R).

But this band has a limited number of sources of mission critical equipment designed specifically for railway use, and a very uncertain future, as the cellular industry wants to phase out GSM in favour of 3G and 4G.

Plus, according SCF Associates estimates, future support for the railways' new wireless networks could ultimately cost over 25 billion EUR and could be in danger because of its cost.

In the same time, mission critical applications are now developing rapidly. Broadband is becoming increasingly important for saving lives, keeping the lights on, preventing accidents and maintaining public order.

In this context, Europe's mission critical services will depend more and more on digital technology rises.

Moreover, the "mission critical" communications scope is larger as the concept is extended from PPDR to other sectors.

In the same time, traditional MNOs are building reliable high speed mobile broadband networks in Europe (chiefly based on LTE). Nevertheless, the 3 sectors have numerous doubts about the exclusive use of these commercial services (rather than using a dedicated network). Doubts rely on:

- pricing schemes (fixed price contracts, even over long periods),
- quality of service overall (network resilience, coverage, etc).

So, emergency services expect government grants of priority resources, such as free spectrum and rights of way. The financial environment (especially through severe budgetary constraints, etc) in several Members States makes it impossible.

To make it short, the main issue of MNO network utilization is that the cost savings (generated by using the MNOs infrastructure) imply insufficient resilience and performance, as only a dedicated network can deliver those but for financial reasons, it is not relevant

Hence, it raises numerous questions based on the viability of commercial mobile networks to be a mission critical solution.

Through this in-depth independent study, European Commission claims an analysis of the costs and benefits of using commercial networks for mission critical purposes.

Feedback from the floor during the debate

Everyone seems to be in line the financial background in Europe and the reasons which pushed the European Commission to order this study.

For the European commission, the main issue is the cost.

Five scenarios

Five scenarios have been considered to explore the options on a cost basis between existing dedicated networks, commercial networks from the MNOs and new LTE commercial equipment hardened for use on a dedicated network.

Figure 37: Comparing the options in dedicated and commercial based networks

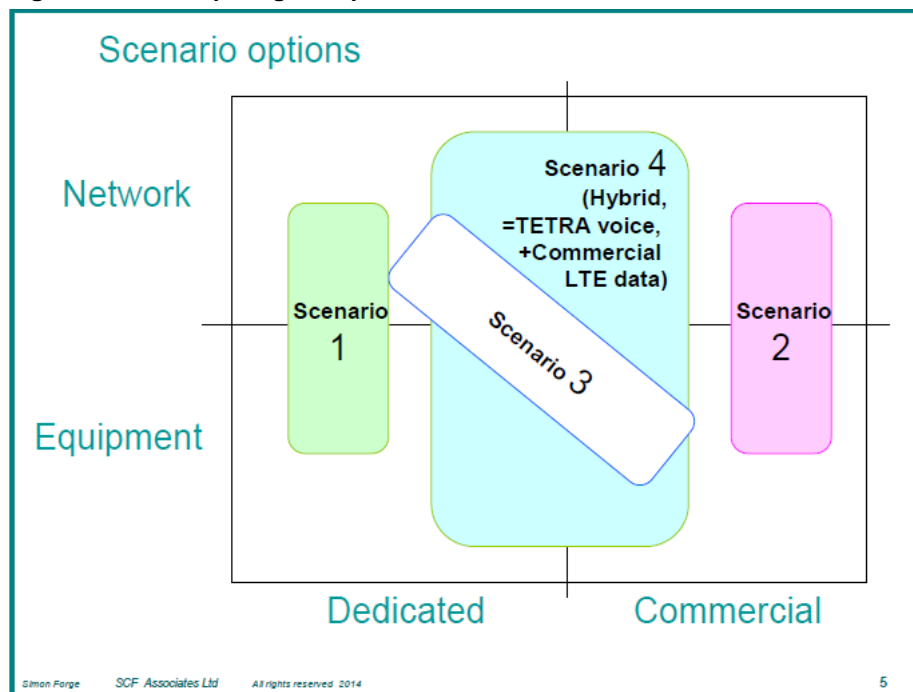

Source: SCF Associates

1. Dedicated networks and dedicated specialised equipment

It looks at continuing with current situation (dedicated networks and dedicated equipment – essentially the costs and benefits of continuing with TETRA/TETRAPOL). It shows that although the costs are high, they can be less than other options.

2. Commercial MNO networks and commercial equipment

The commercial MNO option is based on re-use of the network infrastructure built for commercial services for mission critical applications, by enhanced resilience through “hardening” the LTE networks and extending its patterns of use for faster uplinks. It is assumed that the commercial operation can provide the minimum set of features required.

3. Dedicated networks with commercial networking equipment

Option 3 is related closely to Option 1, being a separate dedicated network with specialised PPDR type equipment. But it differs from Option 1 in moving to commercial mobile radio equipment as much as possible for building the dedicated network (not shared with the general public) with a broadband capability.

4. Hybrid networks

Because of austerity-constrained funding in parts of Europe and the limited amount of dedicated public safety spectrum, various models of mission critical communication are gaining attention. Many stakeholders see TETRA's lack of support for broadband as a serious problem which they wish to address with various "bolt on" schemes. Consequently, as a pragmatic solution, this option turns to the creation of a "hetnet" which integrates both existing mission critical voice networks, in the short term, with future broadband radio networks, both dedicated with their exclusive spectrum, and commercial mobile with licences from auctions.

The FP7 HELP project looked in depth at hybrid solutions and concluded that for a smooth transition, "multi-network solutions are definitely required, involving dedicated and commercial networks, as well as legacy PMR networks".

5. A common multi-purpose network, perhaps regional in scale

Here the objective is to examine whether sharing of a common platform by all three sectors is feasible.

However the concept must go further than the hybrid hetnet of the previous scenario, option 4. That explored a highly robust network federated from existing PPDR and hardened commercial platforms, with interfaces for smart grids in a heterogeneous mix, using a shared core network as its connecting backbone. The latter design is a really a pragmatic architecture for migrating between various network technologies while expanding the functional capability from one sector to three sectors, with high resilience.

These five scenarios explored the options on a cost basis between existing dedicated networks, commercial networks from the MNOs and new LTE commercial equipment hardened for use on a dedicated network. Our conclusions are that on capex measures in costs per user for a density of users for one Member State with well-developed mission critical networking for PPDR extended to the whole EU, hardened commercial networks with geographic extensions for 99% coverage would still be less than dedicated networks having commercial LTE equipment, hardened.

Conclusions on cost comparisons of 5 scenarios

Scenario 2 as the most promising scenario

Overall, Scenario 2 (commercial networks for mobile B/B) is financially the most attractive in terms of cost/value for money and 3-sector support.

It focuses on the use of commercial networks. A crucial cost is that of hardening for resilience, for both the radio access network (RAN) and the core network (government investment for hardening has been assumed). However, the main issue arising from this scenario is not the technology challenge of building a resilient network, but the regulatory, legal and contractual context (the reservations of mission critical users are removed by strong regulatory safeguards).

Indeed, by using commercial mobile networks for broadband functionality, this scenario is the most attractive in terms of value for money when capex and opex are combined, although advantages vary with frequency of operation. The net results, in terms of the cost per user, indicates that at 450 MHz, the dedicated network is cheaper in capex by over 40%, but when taking opex into account over ten years, the sharing of infrastructure costs for personnel and support favours the commercial networks, even when at 800 MHz for the

commercial network. However, if the dedicated LTE network of scenario option 3, with hardened commercial LTE equipment, is operating at 700 MHz, the commercial mobile, at 800 MHz, can give a capex cost per user that is lower than the dedicated scenario of option 3 by some 40%. If MNOs decide to operate commercial mission critical networks in the 700 MHz band, the capex costs would be appropriately reduced from 800MHz, with the base station sites required reducing by up to 20% and costs approximately in proportion.

Comment on other scenarios

For the PPDR community really, Scenario 1 (continuing TETRA for as long as possible) is a short-term solution, but major stakeholders realize value for money is limited by lack of bandwidth for video / imaging and technology maturity.

Scenario 3 - the choice for PPDR migration from TETRA for dedicated networks with dedicated networks based on hardened LTE with UPS (power supply) and diverse routing

For the 3 sectors, Scenario option 4, a hybrid scenario combining existing PPDR networks with a phased move to a common LTE mix of dedicated & commercial:

- Has technical challenges in federating multiple network types
- Offers Member State flexibility in their support and financing decisions for dedicated and/or commercial networks, with decisions as their own pace.
- Critical time-dependent decisions – evolution of LTE standards and spectrum bands for dedicated networks can be accommodated more easily perhaps.

Scenario option 5, a common network especially designed for all three sectors, starts with a fresh concept - a resilient safety network for European emergencies on a larger scale, while supporting all three sectors - a social value decision.

The PPDR operators strongly promote (through numerous spokesmen) the scenario option 4, even though some add that this model is the most expensive as it relies on two different architectures.
On their side, Telcos do not push any scenario in particular.

Value and cost comparison – not comparing like with like SCF ASSOCIATES LTD

Scenario option	Value	Capex & Opex Ratio
1: Dedicated specialised networks using specialised equipment only as for today (TETRA/ TERAPOL)	Limited – voice really Aimed at PPDR	Taken as 100% (Capex €7,150 per user) (Opex €1.35 BN/year)
2 Commercial mobile networks using hardened commercial LTE equipment (800MHz)	High - Broadband at lower cost than Option 1. Possibly all 3 sectors. Opex reduced by shared assets	Capex 70% Opex 44%
3 Dedicated specialised network using hardened commercial equipment At 700MHz: At 450MHz:	Limited - broadband, but mostly for the one sector dedicated to.	Capex 98% at 700MHz Opex 296% Capex 49% at 450MHz Opex 133%
4: Hybrid solutions (10 year spend)	Broadband for all 3 sectors and their specialised needs although more expensive as phase out TETRA slowly	Capex 290% without M2M Data; 180% if 40% capacity for M2M; Opex 400%
5: Feasibility assessment for a common multi-purpose network for all 3 sectors	Feasible project based on concepts of very high resilience for a separate European infrastructure	High

Source: SCF Associates

Conclusions regarding spectrum demand (and related dedicated allocation)

The diversity of policies among Member States makes the dedicated spectrum reservation and allocation choice a necessary option. However, subsequent migration to commercially based services is likely to occur progressively over the next decade, as economic pressures on government budgets increase in the medium term

Nevertheless, a move to commercial networks might be helped rather than hindered by an exclusive spectrum band reservation. This may be later released for commercial provision of service for mission critical purposes by each MS, if financial situation so dictated.

Finally, lower frequencies (400 MHz) are very valuable as propagation range varies with frequency - and controls infrastructure cost.

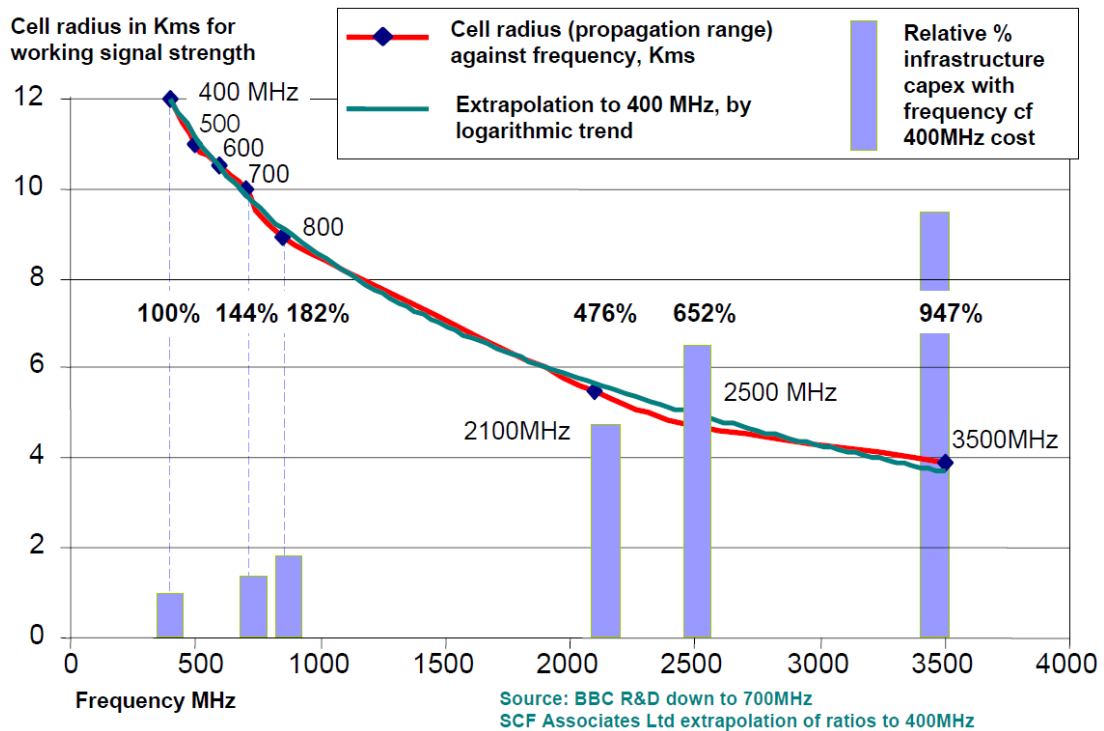

According to Telco spokesmen, the figures in the report are really underestimated as with the 400 MHz introduction, it requires to change the antennas (larger ones).

Conclusion

As a global conclusion, commercial mobile broadband networks to be used for mission critical purposes are a feasible option only if a specific regulatory structure is developed to assure their service level commitment. Otherwise, the risk may be too high and all 3 sectors are highly reluctant to become completely dependent to the MNOs.

Some people from the floor recommend some amendments, notably by suggesting that the “only if” should be replaced by “unless”.

So the key conclusion of the SCF study is that commercial mobile networks could be suitable for mission critical communications within the right legal, regulatory and contractual framework. This conclusion allows each Member State to decide whether to employ MNOs for mission critical communications.

No recommendation has been made by the study to impose a common policy mandate (for example, through an EU Directive). However, Commission guidelines for Member States on NRA roles, actions, powers and responsibilities vis-à-vis MNO contracts with mission critical users might be desirable, perhaps as a Communication.

Here, the issue which has been raised by some people, is that the Commission should have a clear position otherwise each Member state will decide on their own and will have their implementation (and potentially non interoperable).

According to SCF Associates, the situation is solvable and mainly depends on the carriers. The specifications could be included in the licensees (as conditions).

Key positionings

- The Commission does not have preference on any scenarios.
- The debate shows that the Telcos are very reluctant to share their LTE bandwidth (for what they bid at huge price during auctions) for public safety services. They mentioned they are currently facing some issues and they are more obsessed by the stock market rather than by public safety services. The situation of Telcos is quite paradoxical as they tend to be a utility for now and even more in the future (everything is going to be connected) and they still have a strong commercial strategy.
- Public safety operators seem to be enthusiastic regarding the scenario 4 (the hybrid scenario). Some of them also recognized that a bandwidth slice dedicated for their service could be a waste and they can understand the Telco point of view on this point (they are also familiar with the Telco financial situation in Europe).

6.1.3. ExPost analysis– operational requirements of railway radio communications systems

The European Railway Agency published in July 2014 the “Ex-post evaluation – operational requirements of railway radio communications systems”. This report is an ex-post evaluation of today’s railway communication system (GSM-R) which is referenced in the European legal framework within the CCS TSI.

The applied methodology mainly consisted of drafting a questionnaire and summarising the answers to the questionnaire, focusing on negative and positive impacts of the railway communication system on punctuality, safety and interoperability. In addition, the opinion of the different stakeholders is asked for to identify which requirements should be changed or added for the next generation communication systems. In total, around 20 answers were received from different organisations (infrastructure managers, railway undertakings, suppliers, NSAs).

The main conclusions of this study are:

- The system performance of GSM-R is positively contributing to a punctual, safe and interoperable train operation.
- The high availability required for the voice and ETCS data communication services is a key characteristic that will be required in any future system.
- The main functionalities available in GSM-R for voice communication are also key for the operation of the rail services, and they will continue to be required in future systems.
- A fast and simple mechanism for alerting multiple train staff (train drivers, dispatchers) evolution of the system.
- The functionalities available today should be available when the system evolves; there is no major indication of functionalities not used or functionalities missing, therefore, the current set of functional requirements is a valid starting point, although it will have to be periodically reviewed in case any further needs arise.
- Harmonization of the operation is needed in order to be able to promote the use of a common functionality.

7. Annex 7 - The scenarios interact with these evaluation Criteria

For instance, the use of commercial MNO and/or MVNO services without special adaptations probably has implications for various aspects of Effectiveness, including coverage, reliability, robustness (i.e. reliability at times of stress), and so on.

They also interact with Efficiency. Sharing of a network with PPDR could for instance be said to increase Effectiveness by delivering more services, but those services are provided to other stakeholders, not to rail stakeholders. A clearer way to express this benefit is to assume that sharing of the rail network with other uses instead reduces effective cost for the rail network (because it need not fund the entire cost of the infrastructure). The reduced cost then represents a gain in Efficiency.

Expected obsolescence of GSM in general affects cost and maintainability in the longer term.

- We can express this as an impact on both Effectiveness and Efficiency.
- We need to find a way reflect the changing Effectiveness and Efficiency over time into the analysis.

Flexibility was treated by Analysys Mason as an evaluation criterion. We intend instead to map it into Effectiveness, Efficiency and Coherence.

If flexibility increases the ability of the system to meet mandatory and optional elements of the General Objectives, then it is a gain in Effectiveness.

If instead it reduces the risk of stranded investment if technology changes in unexpected ways, then it is reducing the statistical expectation of loss overall, which is a cost reduction and thus an Efficiency gain.

To the extent that interoperability is a minimum requirement, it does not need to also be an evaluation criterion. Any Option worth discussing *must* support interoperability.

After discussion with the stakeholders during the first workshop, we noted the following Criteria to be added to our previous list:

Security: Security embraces the need to mitigate both jamming of radio networks and hacking into IP-based networks. Originally the terms jamming and interferences were used interchangeably but nowadays most radio users use the term "jamming" to describe the deliberate use of radio noise or signals in an attempt to disrupt communications (or prevent listening to broadcasts). Hacking denoted breaking into computer systems or software, and is increasingly being performed for intrusion in IP networks.

Several attendees indicated there needs to be found a criteria dealing with the resistance to jamming, and even hacking though the increasing deployment of IP-based solutions. The fact that railway networks are not in a closed circuit mode and are connected to the Open Internet increases risks of intrusion.

- Migration ability, costs of transition: As the future solution will require both backward compatibility with existing solutions and a step-by-step migration seems to be preferable, there is a need to create a criteria taking this "migration ability" into consideration.

It remains to be assessed if the costs of transition are integrated in this criterion or need to lead to the creation of a new and specific criterion.

- Time sequencing / lifetime: The time development/deployment of the new system needs to be considered when assessing the different solutions likely to be chosen and expected lifetime of these solutions. This criterion becomes particularly relevant when for instance assessing new technologies in new frequency bands (one needs to assess likely spectrum allocation and/or assignment timelines).
- Certification: Terminal certification could be critical, and needs to be reflected in the evaluation. On this point, IDATE and WIK indicated there will be a need for inputs from ERA and the railway community.
- Staff competency requirements: Several attendees indicated that it becomes difficult hiring experienced people in radio/IP networks, and that this has a direct impact on overall costs (costs of training and salary costs). If a given solution requires a strong need to hire and train new staff, the cost and timing have to be taken into account in the assessment.

However, it was also indicated that the need for hiring and training additional staff might be mitigated by alternative solutions such as network sharing/outsourcing.

- Ease of use: It was reported there is a strong requirement to make the system as simple as possible. The term “plug and play” was mentioned.
- Traffic prioritisation: the selected system needs to be able to control traffic overload and manage communication priorities. This needs to be reflected in the Criteria.
- Verifying operator compliance with obligations: how to measure that operators comply with their obligations (QoS) is a strong requirement from the railways community. The services needed by the GSM-R community have to be traceable, and contractable. If not, the services are likely to fail in meeting compliance requirements.

Table 23: Example of factors and requirements for the assessment

Factor / requirement		Relevance	Preconditions / Constraints / Restrictions (e.g. legal, technical)
Punctuality & Safety	the functional requirements (e.g. REC, voice group calls, prioritisation of calls) should be fulfilled		(e.g. public provider could not support REC, so constraint could be that this function is shifted to application layer)
	the availability level of the network model should match the railway service needs	Adapt to service needs (not each line requires a very high availability level > line characteristics)	
	the capacity of the network model should match the railway service needs		
	the performance (QoS) of the network model should be at least the one of the existing network		
Security	Security: the solution should be secure	Availability of different levels of user profiles for the different security levels	
Interoperability	Track-train Interoperability	Network independent behaviour of terminals	Seamless transitions in case of different network models;
Economic efficiency	of RUs: the terminal should be cost efficient	Market size of terminal CAPEX/OPEX of terminals Future proof: interchangeable radio bearer? Migration: co-existence with GSM-R	Placing into service timeframe and further updates Multisystem radio bearers within same physical restrictions (antenna + inside cabin)
	of IM: the network model should be cost efficient	CAPEX/OPEX of network models cost Investment, maintenance & operation Migration: Re-use of assets versus new assets to be built Future proof (SLA: dependency on 'commercial' providers as contracts may not be sufficient to guarantee a long term service)	
	Economic effectiveness of other actors: the spectrum should be used efficiently	Probability of spectrum availability according to EU agenda	